

31 October 2005

Ms. Marlene H. Dortch
Secretary
Office of the Secretary
Federal Communications Commission
445 12th Street, S.W. Room TW-A325
Washington DC 20554

Re: ***Ex Parte Communication***
Petition for Rulemaking to Enhance Security and Authentication Standards for
Access to Consumer Proprietary Network Information, FCC RM-11277

Dear Ms. Dortch:

This is to inform you that Anthony M. Rutkowski, VP of Regulatory Affairs and Standards, in email communications with Jeffery Goldthorp, Chief of the Network, Technology Division of the Office of Engineering and Technology, referenced the attached new Directory Interoperability standard recently developed by the EIDQ industry consortium and adopted by the ITU-T, as a good example of a broad-based industry initiative to produce the kind of capability sought in the instant petition.

Pursuant to the Commission's rules, this *ex parte* letter together with the referenced specification are being filed via the Commission's Electronic Comment Filing System for inclusion in the public record of the above-referenced proceeding.

Respectfully submitted,

/s/

Anthony M. Rutkowski
Vice President for Regulatory Affairs
VeriSign Communications Services Div.
21355 Ridgetop Circle
Dulles VA 20166-6503
tel: +1 703.948.4305
mailto:trutkowski@verisign.com

cc: Jeffery Goldthorp

INTERNATIONAL TELECOMMUNICATION UNION

STUDY GROUP 17

**TELECOMMUNICATION
STANDARDIZATION SECTOR**

TD 1069

STUDY PERIOD 2005-2008

English only

Original: English

Question(s): 2/17

Geneva, 5-14 October 2005

TEMPORARY DOCUMENT

Source: Editor

Title: Draft revised Recommendation E.115, Computerized directory assistance

SUMMARY

This Recommendation gives a detailed description of the principles and procedures to be followed in interconnecting different national computerized directory assistance services, as in the existing version of Recommendation E.115.

Contact: Erik Andersen

Tel: +45 20 97 14 90

e-mail: era@tdcadsl.dk

Attention: This is not a publication made available to the public, but **an internal ITU-T Document** intended only for use by the Member States of ITU, by ITU-T Sector Members and Associates, and their respective staff and collaborators in their ITU related work. It shall not be made available to, and used by, any other persons or entities without the prior written consent of ITU-T.

Draft revised Recommendation E.115

COMPUTERIZED DIRECTORY ASSISTANCE

(revised in 2005)

CONTENTS

	<i>Page</i>
Introduction	8
1 Scope	8
2 Normative References	8
2.1 ITU-T Recommendations.....	8
2.2 ISO/IEC Standards	9
2.3 Other references	9
3 Definitions	9
4 Abbreviations	10
5 Conventions.....	10
6 Basic concepts and models.....	11
6.1 Functional model.....	11
6.1.1 Introduction.....	11
6.1.2 Directory Assistance application.....	11
6.1.3 Directory Assistance protocol.....	11
6.1.4 TCP adaptation protocol	12
6.1.5 Socket interface.....	12
6.1.6 Transmission Control Protocol (TCP).....	12
6.1.7 Internet Protocol (IP).....	12
6.2 Service models	12
7 Principles for the organization of an interconnected computerized international information service.....	14
8 Service specification.....	15
8.1 Inquiry information	15
8.2 Reply information	15
8.3 Conversion	15
8.4 Version 2 extensibility	15
8.5 Functionality	16
8.5.1 General.....	16
8.5.2 Version 1	16
8.5.3 Version 2.....	17
8.5.3.1 Relevant filter items	17
8.5.3.2 Uniqueness of critical filter items	17
8.5.3.3 Subscriber search	17
8.5.3.4 County, state or province search	17
8.5.3.5 Locality search	17
8.5.3.6 Street search	18
8.5.3.7 Business category search.....	18
9 Common protocol specification elements	18
9.1 Character sets, encoding and repertoire	18
9.1.1 General.....	18
9.1.2 Protocol version 1	20
9.1.3 Protocol version 2	20
9.2 Filter concept.....	20
9.3 Matching and matching rules	20

9.3.1	Matching for version 1	20
9.3.2	Matching for version 2	21
9.4	Paging	21
9.5	Hierarchical groups	21
9.6	The keyword concept of version 1	21
10	Version 1 of the Directory Assistance protocol specification	22
10.1	Overview	22
10.2	Inquiry format	22
10.2.1	Structure of the inquiry	22
10.2.2	Inquiry field lengths	22
10.2.3	Part 1 of the inquiry	23
10.2.3.1	Message indicators	23
10.2.3.2	International indicators.....	23
10.2.3.3	Originating terminal code.....	23
10.2.3.4	Date and time	24
10.2.3.5	Message number.....	24
10.2.4	Part 2 of the inquiry	24
10.2.4.1	Locality	24
10.2.4.2	Subscriber name	25
10.2.4.3	Name of street or equivalent	25
10.2.4.4	House number	25
10.2.4.5	Subscriber's forename.....	25
10.2.4.6	Heading in the guide	25
10.2.4.7	Profession code	26
10.2.4.8	Additional information for a selective search	26
10.2.4.9	County, State or Province.....	26
10.2.4.10	Category	26
10.2.4.11	Sequence number	26
10.3	Reply format	26
10.3.1	Structure of the reply.....	26
10.3.2	Field lengths of reply	27
10.3.3	Part 1 of the reply.....	28
10.3.3.1	Message indicator.....	28
10.3.3.2	International indicators.....	28
10.3.3.3	Originating terminal code.....	28
10.3.3.4	Date and time	29
10.3.3.5	Message number.....	29
10.3.4	Part 2 of the reply.....	29
10.3.4.1	Message code	29
10.3.4.2	Country code	29
10.3.4.3	Message.....	29
10.3.4.4	DB selection count	29
10.3.5	Part 3 of the reply	29
10.3.5.1	Structure of Part 3	29
10.3.5.2	National destination code.....	29
10.3.5.3	Subscriber's number	30
10.3.5.4	Locality	30
10.3.5.5	Subscriber name	30
10.3.5.6	Forename.....	30
10.3.5.7	Name of street or equivalent	31
10.3.5.8	House number	31
10.3.5.9	Supplementary data	31
10.3.5.10	Subscriber message	31
10.3.5.11	Heading in the guide	31
10.3.4.12	Profession code	32
10.3.4.13	Additional information for a selective search	32
10.3.4.14	County, State or Province.....	32
10.3.4.15	Category	32
10.3.4.14	Subscriber description	32

11	Version 2 of the Directory Assistance protocol specification	32
11.1	Overview	32
11.2	Inquiry format	33
11.2.1	Structure of the inquiry	33
11.2.2	Inquiry field lengths	33
11.2.3	Inquiry header	35
11.2.3.1	Originating terminal code.....	35
11.2.3.2	Date and time	35
11.2.3.3	Message number.....	35
11.2.3.4	Country name	36
11.2.3.5	Provider code	36
11.2.3.6	Inquiry character set.....	36
11.2.3.7	Reply character set	36
11.2.3.8	Requested reply type.....	36
11.2.3.9	Accepted reply types	37
11.2.4	Inquiry data	37
11.2.4.1	Locality	37
11.2.4.2	Subscriber name	38
11.2.4.3	Name of street or equivalent	38
11.2.4.4	House number	38
11.2.4.5	Subscriber's forename.....	38
11.2.4.6	Heading in the guide	38
11.2.4.7	Profession code	38
11.2.4.8	County, State or Province.....	39
11.2.4.9	Category	39
11.2.4.10	Sequence number	39
11.2.4.11	Postal code	39
11.2.4.12	National Destination Code	39
11.2.4.13	Communications Address	39
11.2.4.14	Communications address types	40
11.2.4.15	Additional naming information	40
11.2.4.16	Communications address service	40
11.2.4.17	Communications address characteristics	41
11.2.4.18	Geographical expansion	41
11.2.4.19	Search coordinate	41
11.2.4.20	Matching rules.....	42
11.2.4.21	Maximum selection level	42
11.3	Reply format	42
11.3.1	Structure of the reply.....	42
11.3.2	Field lengths of reply	43
11.3.3	Reply header	45
11.3.3.1	Originating terminal code.....	45
11.3.3.2	Date and time	45
11.3.3.3	Message number.....	45
11.3.3.4	Message code	45
11.3.3.5	Message.....	45
11.3.3.6	DB selection count	46
11.3.3.7	Reply character set	46
11.3.4	Selections	46
11.3.4.1	Structure of selections	46
11.3.4.2	National destination code.....	46
11.3.4.3	Communications address.....	46
11.3.4.4	Locality	46
11.3.4.5	Subscriber name	46
11.3.4.6	Forename.....	47
11.3.4.7	Name of street or equivalent	47
11.3.4.8	House number	47
11.3.4.9	Supplementary data	47
11.3.4.10	Subscriber message	47
11.3.4.11	Heading in the guide	47

11.3.4.12	Profession code	47
11.3.4.13	County, State or Province.....	47
11.3.4.14	Subscriber description.....	47
11.3.4.15	Category.....	48
11.3.4.16	Country code.....	48
11.3.4.17	Postal code	48
11.3.4.18	Communications address type.....	48
11.3.4.19	Communication address services	48
11.3.4.20	Communications address characteristics	49
11.3.4.21	Distance.....	49
11.3.4.22	Search center	49
11.3.4.23	Additional naming information	49
11.3.4.24	Selection coordinates.....	49
11.3.4.25	Selection level.....	49
12	TCP adaptation protocol.....	50
12.1	Introduction.....	50
12.2	Security	50
12.2.1	Authentication.....	50
12.2.2	Encryption.....	50
12.3	Application connection establishment.....	50
12.3.1	Message format and general procedure.....	50
12.3.2	Field descriptions	51
12.3.2.1	Fields common for all four message types.....	51
12.3.2.2	Fields specific for Negotiation Request	52
12.3.2.3	Field specific for Negotiation Response.....	53
12.3.2.4	Field specific for Negotiation Confirmation Request.....	53
12.3.2.5	Field specific for Negotiation Confirmation	53
12.4	Application data transfer	54
12.5	Application connection release	55
13	Use of the service provided by the TCP protocol.....	55
13.1	TCP connection establishment (socket connection).....	55
13.2	Data transfer.....	55
13.3	TCP connection release.....	55
13.3.1	Orderly release.....	56
13.3.2	TCP ABORT.....	56
14	Operator Manual.....	56
Annex A	Directory Assistance keywords of Directory Assistance protocol version 1.....	57
A.1	Functional keywords Table.....	57
A.2	Descriptive keywords Table.....	64
Annex B	Directory Assistance protocol version 1 in ASN.1.....	65
Annex C	Directory Assistance protocol version 2 in ASN.1.....	67
Annex D	Directory assistance protocol version 2 in XSD.....	71
Annex E	Message codes for the Recommendation E.115	77
Annex F	NACE nomenclature.....	81
F.1	About NACE.....	81
F.2	NACE structure.....	81
F.3	NACE at work.....	81
F.4	Extract from NACE.....	81
Annex G	Examples of BER encodings.....	83
G.1	Introduction.....	83
G.2	Example of ASN.1 BER encoding of the DA protocol version 1	83
G.2.1	Inquiry message	83
G.2.2	Reply message.....	84
G.3	Example of ASN.1 BER encoding of the DA protocol version 2	86

G.3.1	Inquiry message	86
G.3.2	Reply message.....	91

SUMMARY

This Recommendation gives a detailed description of the principles and procedures to be followed in interconnecting different national computerized directory assistance services, as in the existing version of Recommendation E.115.

Draft revised Recommendation E.115

COMPUTERIZED DIRECTORY ASSISTANCE

(revised in 2005)

Introduction

A Directory Assistance (DA) service allows the public to acquire primarily telephone number information, but also information about e-mail addresses; World Wide Web addresses (URLs); and other addressing information necessary for establishing communication.

Service providers offering a DA service keep subscriber information typically in very efficient and elaborate databases. Service providers need to access each other's databases to provide a global service. This Recommendation specifies the protocol, called the DA protocol, to be used for DA information exchange among service providers. The same protocol can be used in other instances, for example, allowing direct public access to DA databases.

This Recommendation specifies two versions of the DA protocol:

- a) version 1 covers basic DA functionality using the ASN.1 Basic Encoding Rules (BER) encoding; and
- b) version 2 covers some enhanced functions and concepts and allows for either:
 - i) XML encodings obtained using either the ASN.1 XER applied to Annex C or using the XSD in Annex D (the same XML results in both cases); or
 - ii) binary encodings obtained using the ASN.1 BER applied to Annex C.

Version 1 shall be supported. Support of version 2 is optional. However, if version 2 is supported, the XML encoding (see (i) of (b1) above) shall be supported, while support for the ASN.1 BER access is optional (see (ii) of (b) above and 12.3.2.1).

Annex A, which is an integral part of this Recommendation, specifies the syntax and semantics of DA keywords for version 1 giving details on how an inquiry shall be processed and giving supplementary information in replies.

Annex B, which is an integral part of this Recommendation, gives the formal ASN.1 specification of version 1 of the DA protocol.

Annex C, which is an integral part of this Recommendation, gives the formal ASN.1 specification of version 2 of the DA protocol.

Annex D, which is an integral part of this Recommendation, gives the formal XSD specification of version 2 of the DA protocol.

Annex E, which is an integral part of this Recommendation, list the messages codes returned in replies, and it lists the conditions under which they are generated.

Annex F, which is not an integral part of this Recommendation, gives a short introduction to the NACE code used for referring to business categories.

Annex G, which is not an integral part of this Recommendation, gives examples of encoding of the Directory Assistance messages using the ASN.1 Basic Encoding Rules.

1 Scope

This Recommendation describes the principles and procedures to be followed on organizing and operating a Computerized International Telephone Directory Assistance Service.

2 Normative References

2.1 ITU-T Recommendations

- ITU-T Rec. E.104 (1995), *International telephone directory assistance service and public access*
- ITU-T Rec. E.164 (1997), *The international public telecommunication numbering plan*

- ITU-T Rec. T.50 (1992), *International Reference Alphabet (IRA) (Formerly International Alphabet No. 5 or IA5) - Information technology - 7-bit coded character set for information interchange*
- ITU-T Rec. X.680 (2002), *Information technology – Abstract Syntax Notation One (ASN.1): Specification of basic notation.*
- ITU-T Rec. X.690 (2002), *Information technology – ASN.1 encoding rules: Specification of Basic Encoding Rules (BER), Canonical Encoding Rules (CER) and Distinguished Encoding Rules (DER).*
- ITU-T Rec. X.693 (2001), *Information technology – ASN.1 encoding rules: XML Encoding Rules (XER).*
- ITU-T Rec. X.693 (2001)/Amd. 1 (2003), *Information technology – ASN.1 encoding rules: XML Encoding Rules (XER). Amendment 1: XER encoding instructions and EXTENDED-XER.*

2.2 ISO/IEC Standards

- ISO 3166 (all parts), *Codes for the representation of names of countries and their subdivisions.*
- ISO/IEC 8859-1:1998, *Information technology - 8-bit single-byte coded graphic character sets - Part 1: Latin alphabet No.1*
- ISO/IEC 10646 : 2003, *Information Technology – Universal Multiple-Octet Coded Character Set (UCS) – Part 1: Architecture and Basic Multilingual Plane.*

2.3 Other references

- IETF RFC 791 (1981), *Internet Protocol.*
- IETF RFC 793 (1981), *Transmission control protocol – DARPA Internet Program – Protocol Specification.*
- IETF RFC 822 (1982), *Standard for the format of ARPA Internet text messages.*
- IETF RFC 1321 (1992), *MD5 Message-Digest Algorithm.*
- IETF RFC 1738 (1994), *Uniform Resource Locators (URL).*

NOTE – The reference to a document within this Recommendation does not give it, as a stand-alone document, the status of a Recommendation.

3 Definitions

For the purposes of this Recommendation, the following definitions apply.

bilateral agreement: For the version 1 protocol, certain protocol elements and keywords shall not be sent to and/or from a replying system unless there is a prior bilateral agreement between the two parties.

communications address: An address through which a resource is accessible, e.g. a telephone number, an e-mail address, a URL, etc.

consumer: The ultimate initiator of an inquiry and the ultimate destination of the reply. A consumer can be Directory Assistance Operator, a public user, an application program, etc.

descriptive keyword: An item that further qualifies a field within a reply.

functional keyword: An item that further qualifies an inquiry.

inquiring system: The component of a Directory Assistance system that issues inquiry messages to a replying system.

inquiry (message): The message as formatted by an inquiring system and sent to a replying system.

listing: The information about a subscriber as stored in the database of a service provider.

NOTE - Other directory specifications use the term *entry*.

reply (message): The message as formatted by a replying system and sent to the inquiring system as the reply to an inquiry.

replying system: The component of a Directory Assistance system that receives inquiry messages from an inquiring system and replies to such inquiries.

requested service: An indication on the service to be provided based on the type user, e.g. operator or public user.

selection: The part of a listing that is returned to an inquiring system as the result of an enquiry.

service provider: An organisation that has access to a database with subscriber information and makes that information available on request.

socket: An endpoint of a two-way communication link between two programs running on the network. A socket is bound to a port number to allow the TCP layer to identify the application for an incoming message.

transaction: An enquiry and its corresponding reply.

transit: Routing of an inquiry through one DA system to another DA system and routing the reply back on the same route.

vendor: An organisation that sells the inquiring and/or replying system software.

4 Abbreviations

ASN.1	Abstract Syntax Notation One
BER	Basic Encoding Rules of ASN.1
DA	Directory Assistance
GSM	Global System for Mobile communications
FTP	File Transfer Protocol
HTTP	Hypertext Transfer Protocol
IETF	Internet Engineering Task Force
IP	Internet Protocol
IRA	International Reference Alphabet
ISDN	Integrated Services Digital Network
MD5	Message Digest 5
MMS	Multimedia Messaging Service
PBX	Private Branch Exchange
PSTN	Public Switched Telephone Network
RC4	Ron's Code 4
RFC	Request For Proposal
SMS	Short Messaging Service
TCP	Transmission Control Protocol
UCS	Universal Multiple-Octet Coded Character Set
UMTS	Universal Mobile Telecommunications System
UTF-8	UCS Transformation Format 8
XER	XML Encoding Rules of ASN.1
XML	eXtensible Markup Language
XSD	XML Schema Definition

5 Conventions

The term "shall" is used whenever an absolute requirement is specified. The term "shall not" is used to specify that something is absolutely forbidden. The term "should" is used whenever something is recommended. The term "should not" is used whenever something is discouraged. The term "may" is used to specify that something is optional.

When protocol fields are referenced in normal text, they are differentiated from normal text by presenting them in the bold Helvetica, 9-point typeface.

An optional field or a field with a default is considered not present if the field is not included at all. For version 1 only, a field is also considered not present, if it has zero length.

6 Basic concepts and models

6.1 Functional model

6.1.1 Introduction

Figure 1/E.115 shows the relationship among the different components constituting a Directory Assistance system.

The left part of the figure reflects the external behaviour of a Directory Assistance system in the form of a set of protocol specifications forming a layered structure. Adherence to these protocols ensures interoperability among systems developed by different vendors at different times. This Recommendation does not specify the structure of the Directory System Application or dictate any particular database technology, only the external behaviour of the system.

The layers below the Socket interface (see 6.1.5) are typically part of the operating system and provide a service to the actual Directory Assistance layers through the Socket interface.

Four different phases of communications can be identified:

- a) Transmission Control Protocol (TCP) connection establishment phase;
- b) an application connection establishment phase with authentication and negotiation of functionalities;
- c) data transfer phase with optional data encryption; and
- d) TCP connection release phase.

The following subclauses introduce the components relevant to this Recommendation.

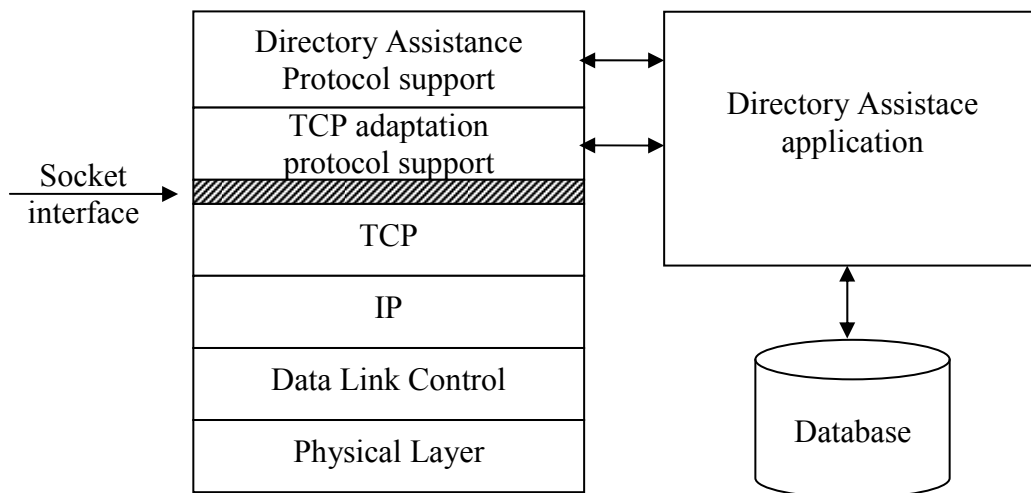

FIGURE 1/E.115

Functional model for Directory Assistance

6.1.2 Directory Assistance application

The Directory Assistance application is responsible for the Directory Assistance by interfacing to and driving the Directory Assistance and TCP adaptation protocols, including interfacing to the TCP through the Socket interface.

The Directory Assistance application performs the actual processing of the information transmitted over the protocol and interfaces to the directory information database as required. Although operation of this application is not subject for standardisation, there are some minimum requirements on the services provided as specified by clauses 7 and 8.

6.1.3 Directory Assistance protocol

This is the protocol carrying the actual information processed by the Directory Assistance application.

This Recommendation specifies two versions of this protocol.

- Version 1 reflects the protocol specified by the 1995 edition of this Recommendation with some approved enhancements. The details of this version are specified in clause 10 and the formal specification is given in Annex B using the ASN.1 notation.
- Version 2 provides some enhancements over version 1. The details of this version are specified in clause 11 and the formal specification given in Annex C using the ASN.1 notation and in Annex D using the XML Schema Definition (XSD) notation.

NOTE – The set of XML documents produced by applying the ASN.1 XER to Annex C is the same as the set of XML documents defined by the XSD in Annex D. The same semantics can also be carried by applying ASN.1 BER to Annex C.

Common protocol specifications are given 9; while version 1 specific specifications are given clause 10 and version 2 specific specifications are given in clause 11.

6.1.4 TCP adaptation protocol

The Transmission Control Protocol/Internet Protocol (TCP/IP) suite is used for interconnecting DA systems. These protocols are used widely and support is integrated within most operation systems (Windows, UNIX, etc.). Use of this well-established protocol suite provides a stable environment for Directory Assistance interworking. It allows communication over the Internet network and private networks (VPNs, Frame Relay, Leased Lines, LANs, ...).

The TCP adaptation protocol bridges the gap between the DA protocol and the service provided by TCP through the Socket interface. It provides the following services to the DA protocol:

- performs authentication of peer systems;
- negotiates the type of service requested;
- negotiates the protocol version and transfer encoding used; and
- optionally performs encryption of inquiries and replies to allow communication over unsafe networks.

The details of this protocol are specified by clause 12.

6.1.5 Socket interface

A TCP socket interface is a conceptual programming interface to the services provided by the TCP layer. It is identified by a combination of an Internet Protocol (IP) address as defined by RFC 791 and a Transmission Control Protocol (TCP) port as defined by RFC 793. A TCP adaptation protocol process can communicate with a similar process in another system using this conceptual interface. A connection between the two TCP adaptation protocol processes is formed by establishing an association between the corresponding sockets.

RFC 793 defines a conceptual socket interface with some pseudo calls for establishing (OPEN) and terminating (CLOSE) connections, and for sending (SEND) and receiving (RECEIVE) messages.

NOTE - The UNIX operating system defines a real programming socket interface and several vendors for non-UNIX operating systems supply likewise some kind of programming socket interface.

6.1.6 Transmission Control Protocol (TCP)

TCP is a connection-oriented protocol, that is, before actual data exchange can take place a formal connection has to be established.

TCP is a reliable end-to-end transport protocol ensuring sequencing and integrity of exchanged messages with respect to incidental problems, such as transmission errors, loss of messages, out of sequence messages, etc. However, it may not ensure protection against wilful and malicious tampering of messages.

While the Internet Protocol (IP), as described in 6.17, allows routing between systems, the TCP provides for routing within the receiving system by use of a so-called port number that identifies the application to handle the incoming message.

6.1.7 Internet Protocol (IP)

The Internet Protocol (IP) is an end-to-end routing protocol that routes messages from end-to-end based on so-called IP-addresses. It can route messages over a tandem of physical networks, for example, LAN → Frame Relay → LAN.

6.2 Service models

For the sake of specifying the communications between two DA systems, the service models shown in Figure 2/E.115 and in Figure 3/E.115 are used for modelling the external behaviour of the systems.

NOTE 1 – This does not imply that systems have to be configured in the ways shown, just that they show the same external behaviour.

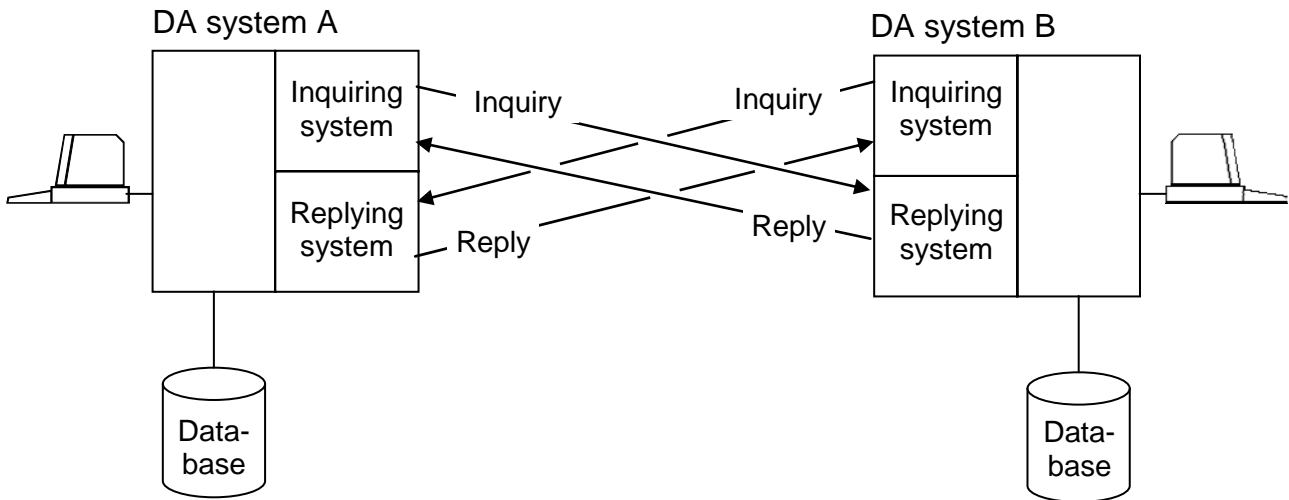

FIGURE 2/E.115

Symmetric service model for Directory Assistance

Figure 2/E.115 shows the symmetric model where two service providers, possibly located in different countries, maintain subscriber databases and have access to each other databases. A user at DA system A, can access information in DA system B, and visa versa. Users are typically telephone operators, but can also be public users, programs, etc.

The figure shows that such systems, at least conceptually, have an inquiring system and a replying system, and that they shall not use the same connection for issuing inquiries and for replying to inquiries. That means that they shall have separate sockets for sending and receiving inquiries. A replying system may use the same IP port number for answering inquiries from several or all of its communications partners.

NOTE 2 – This does not prevent a replying system from having several IP port numbers for receiving inquiries, for either providing back up, for load sharing systems or for separating communications partners.

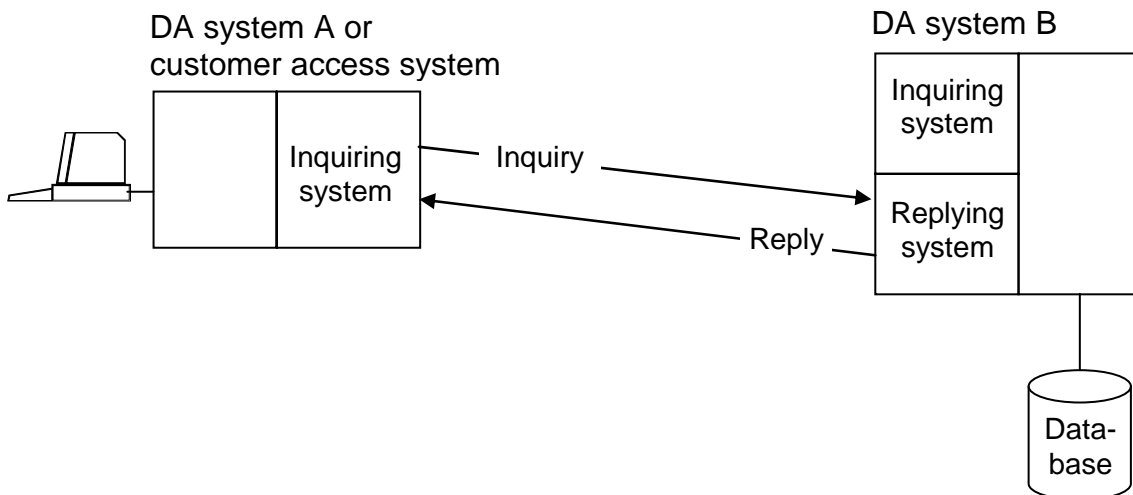

FIGURE 3/E.115

Asymmetric service model for Directory Assistance

Some DA systems do not maintain a subscriber database and are solely providing a DA service by accessing databases of other DA service providers, as illustrated in Figure 3/E.115.

Organisations and institutions may also establish a communication with a DA system using the protocols specified by this Recommendation. This allows direct access to DA information as also illustrated in Figure 3/E.115.

Figure 4/E.115 illustrates the case where a one DA system acts as a transit system between the DA system originating an inquiry and the DA system generating the original reply. The transit system may or may not have a database of its own allowing it to reply to some inquiries directly. The originating inquiring system indicates in the inquiry that it is

intended to be forwarded to a particular DA system different from the one to which it is directly connected (see 11.2.3.4 and 11.2.3.5).

A DA system that can act as a transit system may have a special TCP port for inquiries to be processed directly by the system itself, and it may provide a port for each other system to which it can route inquiries (with **internationalIndicators** for version 1 or **countryName** and **providerCode** for version 2).

When a transit system receives inquiries over a connection using encryption, it should also use a connection to the destination DA system that specifies encryption.

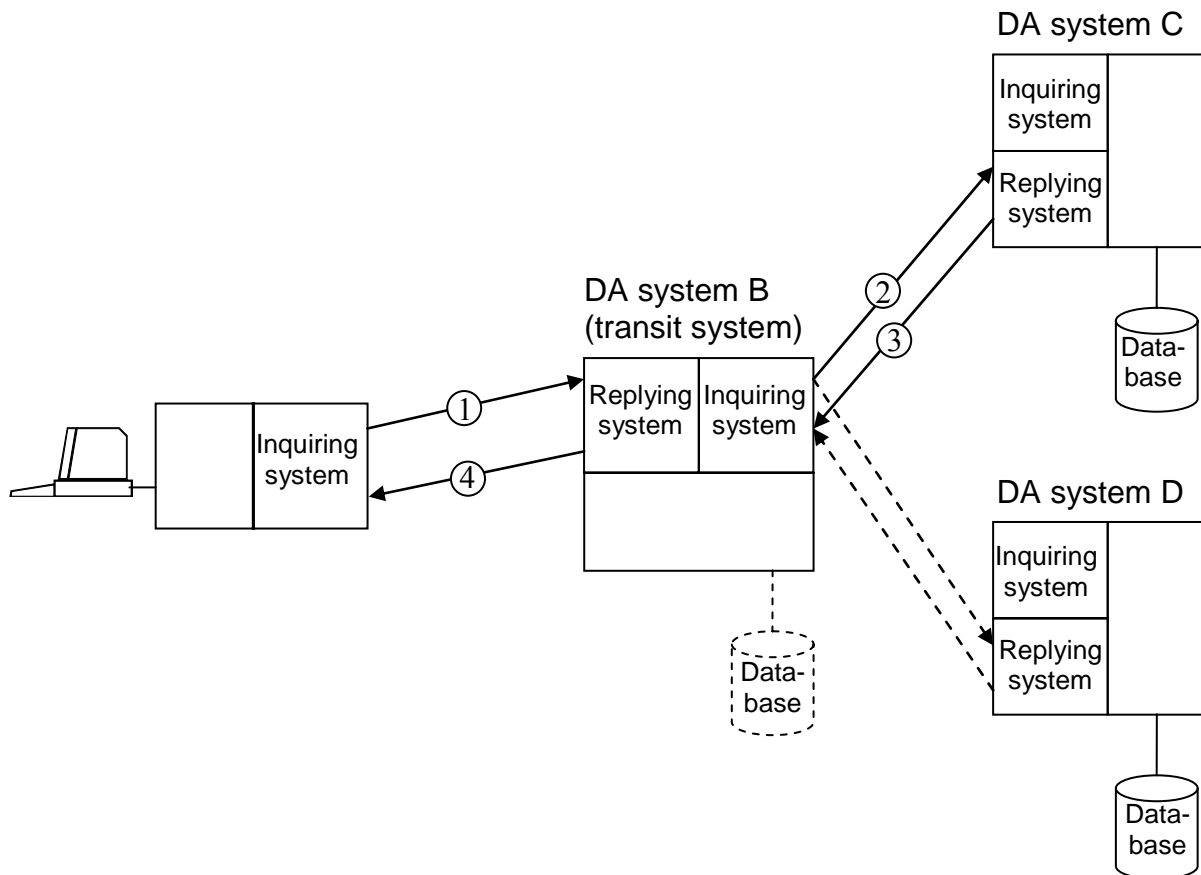

FIGURE 4/E.115
Transit traffic

7 Principles for the organization of an interconnected computerized international information service

For the organization of interconnected computerized international information service, DA systems should abide by the following principles:

- a) An inquiry should be formulated in such a way that the search is targeted to retrieve mostly relevant selections.
- b) To overcome language difficulties, an inquiry to a replying system holding the database to be consulted shall be formulated in the language used in the country of the replying system. This means that the consumer making the inquiry shall resolve the language problems raised by certain inquiry and reply features.

Language problems, which may arise between operators, may be surmounted by using the conversion capability of computers.

- c) An inquiry should give rise to only one reply message with no additional dialogue between computers. The inquiring system shall supply all the information necessary for performing the search. The reply may include several selections. The maximum number of selections returned in a reply message depends both

- on the limitations imposed by internal systems of service providers and on the maximum capacity of the reply. The procedure for subdividing a returned list is given in 9.4.
- d) With regard to the management of messages, there is no relationship between the inquiry and the reply; where for any reason the reply to a particular question has not been obtained, the inquiry must be reiterated by the inquiring DA system and on its own initiative.
 - e) Special numbers for other services such as telefax may also appear in the reply message. The order of presentation for all numbers should remain as contained in the original database to preserve the subscriber's preference for the order of usage.

8 Service specification

When operator access is given via the DA system of one service provider into the DA system of another service provider, minimum standards shall apply to the inquiry and reply process, to permit maximum flexibility in the national information service and compatibility with the international information service.

8.1 Inquiry information

8.1.1 The operator shall request information using the details supplied by the caller, according to the format given in 10.2 for version 1 and in 11.2 for version 2.

8.1.2 At least one optional search field acting as filter item shall be set.

8.1.3 The replying system shall reply to every inquiry. If the replying system indicates that the inquiry information supplied is insufficient, the inquiry should be repeated with more selective information.

8.2 Reply information

8.2.1 The replying system should give the information as available in the database, in order to identify the accuracy of the returned information according to the format given in 10.3 for version 1 and in 11.3 for version 2.

The computer should supply the operator not only with the country code, national destination code and subscriber number, but also with all the elements of identification required in the reply form, as shown in the database, so that, on the basis of this information, the operator can check that the reply corresponds to the inquiry for information.

8.2.2 If the list of selections in the reply is incomplete, it should be possible to obtain the next sequence of selections (see 9.4).

8.2.3 Certain specified conditions, i.e. the number is not available (secret number, no listing, etc.) or further information has to be obtained, shall be indicated by a standardized coded reply.

8.3 Conversion

The different parts of the inquiry formulated by the operator of the inquiring DA system should be converted by the inquiring system into the international standard format. The different parts of the reply transmitted in the international standard format should be converted by the inquiring system into its appropriate format.

8.4 Version 2 extensibility

Protocol version 2 and follow-on versions have a two-level version identification structure: a major version number that is only increased in case of major additions to the protocol, followed by a release identifier, which can be expressed using the figures 0 to 9 or a small letters from a to z. 'a' is considered one level higher than '9', 'b' is one level higher than 'a', etc. This release indicator is incremented one level for each new addition (which can include several new fields and/or values). When the major indicator is incremented, the release level is set back to '0'. The initial level is 2.0 (written as 20 in the protocol).

A major addition that requires a version change is an addition that makes backward compatibility impossible, e.g. introduction of new mandatory fields.

For negotiation of protocol level, see 12.3.2.1.

8.5 Functionality

8.5.1 General

The outcome of a search operation depends on the combination of the fields included in the inquiry.

This Recommendation defines five types of selection lists:

- a) **subscriberList**
- b) **localityList**;
- c) **businessCategoryList**;
- d) **streetList**; and
- e) **provinceList** (version 2 only).

It is version dependent how the replying system determines what type of list to return.

8.5.2 Version 1

The default is that a subscriber search is to be performed. The replying system shall consider all entered fields.

A locality search shall be performed under the following conditions:

- An inquiring system indicates to the replying system that a locality search is to be performed by entering information in the **locality** field, leaving the **subscriberName** field empty and omitting the #ADR, #PRO, #MLS, #MSS, #BUS and the #REV keywords. All other fields are optional.
- When an inquiring system indicates to the replying system that a subscriber search is to be performed, but **locality**, possibly in combination with **countyStateOrProvince** does not specify a single locality, and the #MLS keyword is not present, a **localityList** shall be returned.

If either case above is true, only the following fields shall be taken into account (when entered):

- **locality**;
- **countyStateOrProvince**; and
- **sequenceNumber** (if paging is relevant).

Table 1 describes the possible cases, and what the result would be under above conditions. Many keywords make exceptions to the behaviour described in this table. See comments below.

TABLE 1/E.115

Locality	County, state or province name	Subscriber	Result
Not present	Not present	Not present	Message code indicating that the request cannot be honoured (corresponding message code 43)
Not present	Not present	Present	Search performed in whole country or message code indicating “not supported” (corresponding message code 41)
Not present	Present	Not present	Message code indicating that the request cannot be honoured (corresponding message code 43)
Not present	Present	Present	Search performed in whole province or message code indicating “not supported” (42)
Present	Not present	Not present	Locality list or error
Present	Not present	Present	Locality list, Subscriber list or error
Present	Present	Not present	Locality list or error
Present	Present	Present	Locality list, Subscriber list or error

The presence of the keywords #REV, #ADR, #MLS, #MSS, #PRO and #BUS in the inquiry changes the behaviour described above. Other types of lists may be returned instead of locality list. For more information see Annex A.

8.5.3 Version 2

8.5.3.1 Relevant filter items

The fields within inquiry data (see 11.2.4) may be relevant as filter items as dependent on the type of search:

The way the search is performed is dependent on the values in the **requestedReplyType** and **acceptedReplyType** fields.

The replying system defines which filter items apply to each requested type of list. Examples are:

- **subscriberList**: at least one search filter item (e.g. **subscriberName**).
- **localityList**: **nationalDestinationCode**, **countyStateOrProvince**, **locality**, **postalCode**
- **streetList**: **streetName**, **countyStateOrProvince**, **locality**
- **businessCategoryList**: **headingInTheGuide**
- **provinceList**: **countyStateOrProvince**

8.5.3.2 Uniqueness of critical filter items

The critical filter items, i.e., filter items giving locality information and/or business category information, may individually be unique or non-unique. A critical filter item is unique in its own right if it alone identifies a state, county or province, a locality, a street or a business category. However, if such filter items are not individually unique, they may together be unique. As an example, a locality may in itself be non-unique, but may together with county, state or province uniquely identify a particular location.

It is implementation dependent what combination of critical filter items that are tried against the database to check for uniqueness.

8.5.3.3 Subscriber search

This subclause applies if the **requestedReplyType** specifies **subscriberList**.

This type of search shall be supported.

The **acceptedReplyType** shall be absent or shall have one or more of the following values:

- **localityList**: if no unique locality is found with the search filter then a **localityList** shall be returned.
- **streetList**: if no unique street is found with the search filter and the **streetList** is supported, then a street list shall be returned.
- **provinceList**: if no unique province is found with the search filter and the **provinceList** is supported, then a province list shall be returned.
- **businessCategoryList**: if no unique business category is found with the search filter and the **businessCategoryList** is supported, then a business category list shall be returned.

If **acceptedReplyType** is absent, either a **subscriberList** or an error message code shall be returned.

8.5.3.4 County, state or province search

This subclause applies if the **requestedReplyType** specifies **provinceList**.

If this type of search is not supported, then message code 45 shall be returned.

If **acceptedReplyType** is absent, either a **provinceList** or an error message code shall be returned.

NOTE – The **acceptedReplyType** will typically be absent.

8.5.3.5 Locality search

This subclause applies if the **requestedReplyType** specifies **localityList**.

This type of search shall be supported.

The **acceptedReplyType** shall be absent or have the following value:

- **provinceList**: if no unique county, state or province is found with the search filter, all locality filters are absent and the **provinceList** is supported, then a **provinceList** should be returned.

If **acceptedReplyType** is absent, either a **localityList** or an error message code shall be returned.

8.5.3.6 Street search

This subclause applies if the **requestedReplyType** specifies **streetList**.

If this type of search is not supported, then message code 45 shall be returned.

The **acceptedReplyType** shall be absent or have one or more of the following values:

- **localityList**: if no unique locality is found with the search filter, then a **localityList** shall be returned.
- **provinceList**: if no unique county, state or province is found with the search filter, all locality filters are absent and the **provinceList** is supported, then a **provinceList** should be returned.

If **acceptedReplyType** is absent, either a **streetList** or an error message code shall be returned.

When a **streetList** is returned, each selection shall have the following fields:

- **streetName**;
- **locality**;
- **countyStateOrProvince** if necessary for unambiguity; and
- optionally, additional information in **supplementaryData** field.

8.5.3.7 Business category search

This subclause applies if the **requestedReplyType** specifies **businessCategoryList**.

If this type of search is not supported, then message code 45 shall be returned.

The **acceptedReplyType** shall be absent or have one or more of the following values:

- **localityList**: if no unique locality is found with the search filter then a **localityList** should be returned.
- **provinceList**: if no unique province is found with the search filter, all locality filters are absent and the **provinceList** is supported, then a **provinceList** should be returned.
- **streetList**: if no unique street is found with the search filter and the **streetList** is supported, then a **streetList** should be returned.

If **acceptedReplyType** is absent, either a **businessCategoryList** or an error message code shall be returned.

9 Common protocol specification elements

9.1 Character sets, encoding and repertoire

9.1.1 General

For international traffic, the character repertoire is generally restricted to a common subset available at all operator input stations. The minimum character set that shall be employed for inquiries and replies is listed in table 2/E.115.

This minimum character set shall be coded in accordance with ITU-T Rec. T.50 using the IRV allocation.

The characters quotation mark ("), ampersand (&), apostrophe (') less-than sign (<) and greater-than sign (>) cannot be included in XML values.

- the quotation marks shall be replaced by """ or by """
- the ampersand shall be replaced by "&" or by "&"
- the apostrophe shall be replaced by "'" or by "'"
- the less-than-sign shall be replaced by "<" or by "<"
- the greater-than sign shall be replaced with ">" or by ">"

NOTE – Some parsers may do the conversion automatically.

TABLE 2/E.115

Graphi c symbol	Name	Coded representation	Graphi c symbol	Name	Coded representation
	Space	2/0	L	Latin capital letter L	4/12
!	Exclamation mark	2/1	M	Latin capital letter M	4/13
“	Quotation mark	2/2	N	Latin capital letter N	4/14
#	Number sign	2/3	O	Latin capital letter O	4/15
%	Percent sign	2/5	P	Latin capital letter P	5/0
&	Ampersand	2/6	Q	Latin capital letter Q	5/1
'	Apostrophe	2/7	R	Latin capital letter R	5/2
(Left parenthesis	2/8	S	Latin capital letter S	5/3
)	Right parenthesis	2/9	T	Latin capital letter T	5/4
*	Asterisk	2/10	U	Latin capital letter U	5/5
+	Plus sign	2/11	V	Latin capital letter V	5/6
,	Comma	2/12	W	Latin capital letter W	5/7
-	Hyphen, minus sign	2/13	X	Latin capital letter X	5/8
.	Full stop	2/14	Y	Latin capital letter Y	5/9
/	Solidus	2/15	Z	Latin capital letter Z	5/10
0	Digit zero	3/0	-	Low line, underline	5/15
1	Digit one	3/1	a	Latin small letter a	6/1
2	Digit two	3/2	b	Latin small letter b	6/2
3	Digit three	3/3	c	Latin small letter c	6/3
4	Digit four	3/4	d	Latin small letter d	6/4
5	Digit five	3/5	e	Latin small letter e	6/5
6	Digit six	3/6	f	Latin small letter f	6/6
7	Digit seven	3/7	g	Latin small letter g	6/7
8	Digit eight	3/8	h	Latin small letter h	6/8
9	Digit nine	3/9	i	Latin small letter i	6/9
:	Colon	3/10	j	Latin small letter j	6/10
;	Semicolon	3/11	k	Latin small letter k	6/11
<	Less-than sign	3/12	l	Latin small letter l	6/12
=	Equals sign	3/13	m	Latin small letter m	6/13
>	Greater-than sign	3/14	n	Latin small letter n	6/14
?	Question mark	3/15	o	Latin small letter o	6/15
@	Commercial at ¹⁾	4/0	p	Latin small letter p	7/0
A	Latin capital letter A	4/1	q	Latin small letter q	7/1
B	Latin capital letter B	4/2	r	Latin small letter r	7/2
C	Latin capital letter C	4/3	s	Latin small letter s	7/3
D	Latin capital letter D	4/4	t	Latin small letter t	7/4
E	Latin capital letter E	4/5	u	Latin small letter u	7/5
F	Latin capital letter F	4/6	v	Latin small letter v	7/6
G	Latin capital letter G	4/7	w	Latin small letter w	7/7
H	Latin capital letter H	4/8	x	Latin small letter x	7/8
I	Latin capital letter I	4/9	y	Latin small letter y	7/9
J	Latin capital letter J	4/10	z	Latin small letter z	7/10
K	Latin capital letter K	4/11			

1) Not part of basic subset, but its implementation is recommended. If not implemented, it shall be replaced by (a) when representing **rfc822** (e-mail) addresses

9.1.2 Protocol version 1

Through bilateral agreement, the graphic characters of the extended character set defined by ISO/IEC 8859-1 may be used. The following codes points are relevant:

- a) the repertoire as specified by Table 2/E.115; and
- b) 10/00 (Hex 00a0) to 15/15 (Hex ff)

NOTE – The repertoire and encoding specified in a) is identical in encoding to the one specified in 9.1.1

9.1.3 Protocol version 2

Version 2 of the DA protocol requires the use of the UCS Transformation Format 8 (UTF-8) encoding of Universal Multiple-Octet Coded Character Set (UCS) as defined by ISO/IEC 10646-1.

The part of BASIC LATIN subset listed in Table 2/E.115 shall be implemented. This restricted BASIC LATIN subset is in the protocol represented by the **basic** ASN.1/XML value.

NOTE – The encoding of this subset is identical in repertoire and encoding to the one specified in 9.1.1.

If for some local purposes a more extensive character repertoire is required, additional subsets may be selected as defined by Annex A of ISO/IEC 10646-1.

The **latin1** ASN.1/XML protocol value is used for selecting Latin-1 Supplement as an addition to the repertoire defined by **basic**.

NOTE – This character repertoire extends the graphical character repertoire to the one defined by ISO/IEC 8859-1, although the encoding is different.

9.2 Filter concept

When receiving a valid inquiry, the search engine matches relevant fields of the inquiry against similar fields of the listings in the database. The inquiry fields used for matching against listings comprise the *filter*. If the match yields TRUE for a listing, a selection is formed from that listing and returned in the reply, possibly together with other similar selections.

Each inquiry field that is part of the filter is called a *filter item*. If a filter item matches a corresponding field of a listing, it is said to yield TRUE. For a filter to yield TRUE, i.e. for the filter to match a listing, all the filter items have to yield TRUE for that listing (the filter items are AND'ed).

NOTE – Although a selection is a candidate to be returned, local policies may prevent that selection from being returned.

Matching does not necessarily imply a simple octet-by-octet comparison, but can be more sophisticated as specified by matching rules (see 9.3).

A filter item can hold truncated information to be matched against part of the corresponding listing field.

A filter item may consist of subcomponents that individually have to match corresponding information items of the listings. The combined results may be the logical OR of the matching result of each subcomponent. As an example, see 11.2.4.14.

9.3 Matching and matching rules

Different fields of an inquiry message are matched against the corresponding fields of the listings in the database of the replying system. If all the fields match a particular listing, selective information from that listing, referred to as a *selection*, is returned, possibly together with other selections from other listings that also match the inquiry fields.

A matching rule is a specification for how a particular matching should be performed.

9.3.1 Matching for version 1

The following matching rules are defined:

- a) Phonetic match. This type of matching deploys an implementation-defined phonetic matching algorithm.
- b) Word rotation match
- c) Position sensitive match (#ALT=2)

Replying systems shall apply their standard matching, if an alternative matching rule is not provided in the #ALT keyword.

9.3.2 Matching for version 2

Matching rules for version 2 are defined in 11.2.4.20.

9.4 Paging

There is a limit on the amount of data to be returned as the result of an inquiry. If that limit is exceeded, it is necessary to split the result up into pieces, called *pages*. The inquiry indicates which page to be returned by the **sequenceNumber** field as specified in 10.2.4.11 for version 1 and in 11.2.4.10 for version 2.

In version 1, the length of a page shall be maximum 3000 octets, and it shall contain an integral number of selections.

In version 2, a page shall consist of an integral number of selections up to a value as determined by means outside of this Recommendation. This value shall be configurable per inquiring system.

NOTE – It is recommended that this value is set to 30.

A listing shall not exceed 10 pages (sequence numbers 0 to 9).

9.5 Hierarchical groups

Listings may have hierarchical relationship. *Hierarchical groups* form such relationships by forming a logical tree with a root called the *hierarchical top*.

NOTE – Version 1 of the protocol refer to hierarchical groups as *grouped listings*.

By referring to hierarchical relationships, it is possible in a search operation to retrieve information from listings matching a search enquiry, but also from other listings within the same hierarchical group.

Information from each listing of a hierarchical group is returned as a separate selection.

When the replying system returns selections from a hierarchical group, it shall indicate the level of the corresponding listing within the hierarchical group.

The top level of a hierarchical group has level 0.

The level indication for version one is expressed using the keywords #MAI and #LEV (see 9.6 and Annex A) and in for version 2 in inquiry and reply fields (see 11.2.4.21 and 11.3.4.25).

9.6 The keyword concept of version 1

Version 1 of the DA protocol has the concept of keywords. A keyword consists of the number sign (#) followed by three upper case letters that qualifies either an inquiry or a reply. The defined keywords are listed in Annex A.

Keywords have no defaults in the sense that if a keyword is not supplied, there is no default functionality implied by its absence.

Version 1 defines two types of keywords:

- descriptive keywords; and
- functional keywords.

Descriptive keywords are returned in replies to signal the kind of communications address retrieved. Descriptive keywords are returned within the **supplementaryData** field in the reply (see 10.3.5.9). The defined descriptive keywords are listed and described in Annex A.

Descriptive keywords may be used without bilateral agreement.

Functional keywords included in the inquiry provide additional information to be applied to tailor the search to get the wanted result. Some functional keywords have may have a value assigned using the format:

#XXX=<value>

Functional keywords are supplied in the **additionalInformationForASelectiveSearch** field of the inquiry and/or reply (see 10.2.4.8 and 10.3.4.13) as detailed in Annex A.

A functional keyword shall not be used unless there is a bilateral agreement on its use.

10 Version 1 of the Directory Assistance protocol specification

10.1 Overview

A DA transaction consists of an inquiry and a reply. The format of the inquiry is shown in figure 6/E.115. The details are given in 10.2. The format of the reply is shown in Figure 7/E.115. The details are given in 10.3.

Several transactions may be in progress simultaneously on the same connection between an inquiring system and a replying system. Replies may come back in a different order than the order of inquiries. The originating terminal code field (see 10.2.3.3) is used for paring inquires and replies.

10.2 Inquiry format

10.2.1 Structure of the inquiry

The structure of an inquiry is shown in Figures 6/E.115. It reflects the information as entered by an operator (or user) and formatted by the inquiring system. The information is used by the replying system to search the database for listings that match the inquiry.

Part 1					Part 2		
Message indicators	International indicators	Originating terminal code	Date and time	Message number	locality	Subscriber name	Street name or equivalent

Part 2 (end)							
House number	Forename	Heading in the guide	Profession code	Additional information for a selective search	County, State or Province	Category	Sequence number

FIGURE 6/E.115

Inquiry format for version 1

The different fields of the inquiry for version 1 are described in 10.2.3 and 10.2.4.

10.2.2 Inquiry field lengths

Table 3/E.115 lists the inquiry field length in characters of the different fields. Some fields have a fixed length, while other fields have variable length with a specified maximum length. A compliant implementation shall be able to receive inquiry messages up to the mandatory maximum or fixed length. Version 1 implementations may by bilateral agreements send up to the number of characters given in the *Bilateral* column.

TABLE 3/E.115

Field	Mandatory	Bilateral	
messageIndicators	Exact 4	N/A	P a r t 1
internationalIndicators	Exact 8	N/A	
originatingTerminalCode	Exact 8	N/A	
dateAndTime	Exact 12	N/A	
messageNumber	Exact 4	N/A	

TABLE 3/E.115 (Completed)

Field	Mandatory	Bilateral	
locality	Max. 70	Max. 256	P a r t 2
subscriberName	Max. 80	Max. 256	
streetName	Max. 70	Max. 256	
houseNumber	Max. 10	Max. 256	
forename	Max. 60	Max. 256	
headingInTheGuide	Max. 30	Max. 256	
professionCode	Max. 30	Max. 256	
additionalInformationForASelectiveSearch	Max. 30	Max. 256	
countyStateOrProvince	Max. 30	Max. 256	
category	Max. 30	Max. 256	
sequenceNumber	Exact 1	N/A	

10.2.3 Part 1 of the inquiry

10.2.3.1 Message indicators

This mandatory field signals the inquiry is Directory Assistance inquiry. It shall be filled with the four characters: \$ C R I.

If the length of the field is not exactly 4 characters, message code 22 shall be returned by the replying system.

NOTE – This field has no significance for the search, so although the inquiring system is required to fill this field exactly as specified, the replying system should not check the content of this field, only the length.

10.2.3.2 International indicators

This mandatory field identifies the country codes of both the replying and inquiring systems. These codes consist of the country code as defined by ITU-T Rec. E.164. It has the following format:

xxxxyyyy

Where

- xxxx = country code of replying system (recipient);
- yyyy = country code of inquiring system (sender).

Example: 00320031 – An inquiry goes from Netherlands to Belgium.

If the length of the field is not exactly 8 characters, message code 22 shall be returned by the replying system.

10.2.3.3 Originating terminal code

This mandatory field holds a value generated by the inquiring system. The replying system shall echo this value in the reply (see 10.3.3.3).

This field allows an inquiring system to pair a reply with the corresponding inquiry and thereby route the reply back to the source of the inquiry, e.g. a particular workstation.

An inquiring system shall ensure that it does not issue an inquiry with the same value as for an outstanding inquiry against a particular replying system.

If the length of the field is not exactly 8 characters, message code 22 shall be returned by the replying system.

10.2.3.4 Date and time

This optional field gives the date and time of the origin of the inquiry.

Format: YYMMDDHHMMSS

If this field is present, it shall be echoed unchanged by the replying system back to the inquiring system (see 10.3.3.4).

If the length of the field is not exactly 12 characters, message code 22 shall be returned by the replying system.

NOTE – This field has no significance for the search, so the replying system should not check the content of this field, only the length.

10.2.3.5 Message number

This optional field holds a message number generated by the inquiring system.

If this field is present, the content shall not be checked by the replying system, but shall be echoed unchanged back to the inquiring system (see 10.3.3.5).

If the length of the field is not exactly 4 characters, message code 22 shall be returned by the replying system.

10.2.4 Part 2 of the inquiry

This part of the inquiry has basic fields as defined in 10.2.4.1-10.2.4.2 and additional fields to improve the search as defined in 10.2.4.3-10.2.4.11.

10.2.4.1 Locality

The name of the locality shall be introduced according to its exact spelling.

Abbreviations are not permitted, except for the words “Sint”, “Saint”, “Sankt”, “San”, ..., which are abbreviated by the letter “S” followed by a space.

The locality name and county, state or province name (if supported) may be truncated. If this combination, when a search for subscribers is requested, matches more than one locality, a **localityList** shall be returned, unless a multiple location search is performed as specified in 8.5, in which case a **subscriberList** may be returned..

If the locality information identifies a single locality, the subscriber search shall be performed.

The mandatory minimum number of characters to be input should be fixed by each service provider and be mentioned in an Operator Manual. The inquiring system should check whether this minimum is respected.

When a word is terminated by a full stop this implies that the word is complete, when a word is not terminated by a full stop this implies that the word might be either complete or not complete. When a specification consists of more than one word, the full stop is additional to the separating space. (DEN HAAG would be specified as “DEN.□HAAG” and not “DEN.HAAG”, the □ is supposed to represent a blank).

The matching to be performed will be the following:

- words in the name may be truncated (may even be empty);
- completeness of a word may be indicated by a full stop that follows the word;
- absence of the above-mentioned full stop does not imply that the word is not complete.

To indicate that the number of words in the inquiry is complete, the character “#” may be used, and it shall then be inserted at the end of the field. Absence of the character “#” does not imply that not all words are present. If both the full stop, to indicate that the last word is complete, and the number sign are present, the full stop shall precede the number sign.

If the **countyStateOrProvince** field is present and the **locality** field does not specify a location within that area, then message code 64 shall be returned, with the exception as listed below for the protocol version specific considerations.

This field may instead of a locality name hold a postal code, if the postal code can be used for locating subscribers. The reply shall include the locality name.

If the locality given is not part of the county, state or province given, but is part of another county, state or province, then the replying system may optionally return a **localityList** with this other county, state or province name together with the locality name.

10.2.4.2 Subscriber name

Subscriber name is either surname or trade name of the subscriber.

The subscriber's surname should be input according to its exact spelling.

Abbreviations should not be allowed. The mandatory minimum number of characters to be input should be fixed by each service provider and be mentioned in the Operator Manual.

The replying system should check whether this minimum is respected. When a word is terminated by a full stop this implies that the word is complete, when a word is not terminated by a full stop this implies that the word might be either complete or not complete. When a specification consists of more than one word, the full stop is additional to the separating space.

When the subscriber's surname or trade name is replaced by initials, the characters composing the acronym shall be introduced successively without being separated by special signs or spaces.

NOTE 1 – Special signs are characters of the repertoire defined in 9.1.1 with the exception of the 26 small and 26 capital letters (a-z and A-Z) and the figures 0-9.

NOTE 2 – As examples, C&A or C & A shall be transmitted as CA and F.N.C.B. shall be transmitted as FNCB.

It is recommended to add the full stop when the acronym or abbreviation is fully specified (example: NATO.).

Numbers forming part of names or acronyms shall be introduced as numeric characters.

Some countries require the introduction of an additional family name (e.g. second family name, grandfather name, etc. When relevant, this additional family name shall be entered as follows:

The additional family name shall be included in **subscriberName** field. It shall follow the subscriber name, if any, and it shall be preceded by an equal sign. There shall be no spaces before and after the equal sign. Both the subscriber name and the additional family name are filter items to match against the listings of the database.

NOTE – In Annex A, only the term *second family name* is used

The support for additional family name is mandatory.

10.2.4.3 Name of street or equivalent

The name of the street shall be input according to its exact spelling.

The words “Sint”, “Saint”, “Sankt”, “San”, ... should be abbreviated by the letter “S” followed by a space. The mandatory minimum number of characters to be input should be fixed by each service provider and be mentioned in the operator's manual. The inquiring system should check whether this minimum is respected. When a word is terminated by a full stop this implies that the word is complete, when a word is not terminated by a full stop this implies that the word might be either complete or not complete. When a specification consists of more than one word, the full stop is additional to the separating space. Numbers forming part of the name of the street shall be introduced as numeric characters.

10.2.4.4 House number

This field identifies a house within a street. A possible numerical part of the house number shall precede the possible alphabetical part without separation. Non-significant zeros shall be omitted.

10.2.4.5 Subscriber's forename

Entire forenames, initials or a combination of forenames and initials shall always be separated by spaces.

10.2.4.6 Heading in the guide

This field shall be used for holding the business category when relevant. When this field is present, it acts as a filter item.

The business category describes for a business, institutional or government subscriber, the activity domain in which the business, institution or administrative authority is involved.

NACE codes may be used to refer to business categories to surmount language problems (see Annex F).

It may be a general category, e.g. Telecommunications, Administrations, or a more specific activity, e.g. Telecommunication mobile telephony, Railways.

Example:

Hospitals	(Heading in the guide)	
Saint Luc		Grouped entry
Church Street 12	number	
Reception		
Inquiries	number	
Emergencies	number	
Saint Anthony Heaven Lane 2..	number	Single entry
Saint Mary		Grouped entry
Dead End 69	number	
Reception		
Inquiries	number	
Emergencies	number	

10.2.4.7 Profession code

This optional field shall not be present for other than residential subscribers and this field shall not be present, unless there exists a bilateral agreement on its use.

This field, when present, specifies for a residential subscriber the profession, job (or academic title) and acts as a filter item.

10.2.4.8 Additional information for a selective search

This field is used for entering functional keywords (see 9.6). Multiple keywords shall be separated by a single space.

Additional data shall only be introduced if a bilateral agreement exists on its use. Each service provider will have to identify its specific use of this field and describe it in the Operator Manual.

10.2.4.9 County, State or Province

This field shall not be present, unless there exists a bilateral agreement on its use.

The matching to be performed will be the following:

- word in the name can be truncated (can even be empty);
- completeness of a word can be indicated by a full stop that follows the word;
- absence of the above-mentioned full stop does not imply the word is not complete.

10.2.4.10 Category

This optional field may supply information about the subscriber category. When present, it will act as filter item to narrow the selections to be only of the requested category.

One and only one of the following upper case codes shall be placed in this field: **B** for Business, **R** for Residential and **G** for Government.

10.2.4.11 Sequence number

The sequence number indicates which page of the reply shall be sent (see 9.4). The number 0 (zero) (or if the field is omitted) indicates the first page, the number 1 the second page, etc. This number shall not be greater than 9.

10.3 Reply format

10.3.1 Structure of the reply

The structures of a reply is shown in Figures 7/E.115. It reflects the information returned by a replying system. If relevant, this information is assumed to be converted by the inquiring system into a format suitable for the presentation at the workstation.

If the amount of information to be returned is substantial, the replying system shall split selections into pages as discussed in 9.4.

Part 1					Part 2			
Message indicators	International indicators	Originating terminal code	Date and time	Message number	Message code	Country code	Message	DB selection count

Part 3							
National destination code	Subscriber number	Locality	Subscriber name	Forename	Street name or equivalent	House number	Supplementary data

Part 3 (end)						
Subscriber message	Heading in the guide	Profession code	Additional information for a selective search	County, State or Province	Category	Subscriber description

FIGURE 7/E.115

International reply format for version 1

The different fields of the reply for version 1 are described in 10.3.3, 10.3.4 and 10.3.5.

10.3.2 Field lengths of reply

Table 4/E.115 lists the different fields with length requirements in characters. For variable length fields the maximum field length is given. A compliant implementation shall be able to receive inquiry messages up to the mandatory length dependent on the version supported. Version 1 implementation may by bilateral agreements send up to the number of characters in the *Bilateral* column.

TABLE 4/E.115

Field	Mandatory	Bilateral	
messageIndicators	Exact 4	N/A	P a r t 1
internationalIndicators	Exact 8	N/A	
Originating terminal code	Exact 8	N/A	
Date and time	Exact 12	N/A	
Message number	Exact 4	N/A	
Message code	Exact 2	N/A	P a r t 2
Country code ¹⁾	Exact 4	N/A	
Message	Max. 80	Max. 256	
dbSelectionCount	Max. 10	N/A	

TABLE 4/E.115 (Completed)

Field	Mandatory	Bilateral	
National destination code	Max. 13		P a r t 3
Subscriber's number	Max. 14		
Locality	Max. 70	Max. 256	
Surname or trade name of subscriber	Max. 80	Max. 256	
Subscriber's forename	Max. 60	Max. 256	
Name of street or equivalent	Max. 70	Max. 256	
House number	Max. 10	Max. 256	
Supplementary data	Max. 30	Max. 256	
Subscriber message	Exact 1	Max. 256	
Heading in the guide	Max. 30	Max. 256	
Profession code	Max. 30	Max. 256	
Additional information for a selective search	Max. 30	Max. 256	
County, State or Province	Max. 30	Max. 256	
Category	Max. 30	Max. 256	
subscriberDescription	N/A	Max. 256	

10.3.3 Part 1 of the reply

This part of the reply holds general information not directly related to the individual returned selections (if any).

10.3.3.1 Message indicator

This mandatory field signals that the reply is a reply to a Directory Assistance inquiry from one DA system to another DA system. It shall be filled with the four characters: \$ C R I.

10.3.3.2 International indicators

This mandatory field identifies both the codes of the country of the replying and inquiring systems. These codes consist of the country code as defined by ITU-T Rec. E.164. It has the following format:

yyyyxxxx;

Where

- yyyy = country code of inquiring system (recipient);
- xxxx = country code of replying system sender).

Example: 00310032 – The reply goes from Belgium to Netherlands.

10.3.3.3 Originating terminal code

This mandatory field shall echo the corresponding field of the inquiry (see 10.2.3.3).

10.3.3.4 Date and time

If the corresponding field is present in the inquiry (see 10.2.3.4), this field shall echo the date and time as generated by the inquiring system. Otherwise, this field shall be absent.

10.3.3.5 Message number

If the corresponding field is present in the inquiry (see 10.2.3.5), this field shall echo the message number as generated by the inquiring system. Otherwise, this field shall be absent.

10.3.4 Part 2 of the reply

10.3.4.1 Message code

This mandatory field signals the outcome of the inquiry. The message codes are defined in Annex E.

NOTE – If the user is a human being, it is assumed that the inquiring system will convert the message code to a text message.

10.3.4.2 Country code

This mandatory field shall hold the common ITU-T Rec. 164 country code for the selections within Part 3. It shall be placed in the first part of the field and padded with spaces up to four characters.

This value may be superseded for a particular selection with a value supplied by the CCO keyword (if a bilateral agreement exists).

10.3.4.3 Message

This field should only be used for urgent messages, for example to announce short interruptions that cannot be announced in time in ways normally agreed upon among service providers.

It shall be sent with every reply as long as it is relevant, but not for more than 5 minutes.

It is a free text field. The message shall be in the English language.

The following are examples of urgent messages:

System will be down from date/time GMT until date/time GMT

System will be down from date/time GMT for about 10 minutes

10.3.4.4 DB selection count

This optional field provides a figure that indicates the number of selections that have been found by the replying system. If this figure is prefixed a greater-than sign (>) it indicates that the number of selections exceeds this figure.

This field shall not be included unless there exists a bilateral agreement on its use.

10.3.5 Part 3 of the reply

10.3.5.1 Structure of Part 3

If no selection was found to be returned, then one selection shall be returned echoing information from the corresponding inquiry as detailed for the individual fields.

NOTE – An inquiring system should be tolerant with respect to the presence of such an echo-selection and should rely on the message code and locally retained inquiry information.

If several communications addresses are to be returned for a given subscriber, then a selection shall be returned for each communications address.

10.3.5.2 National destination code

This field shall be present when a national destination code exists, a subscriber is found, it is an e164 type communication address and the subscriber's number may be disclosed. It shall be formatted as defined by ITU-T Rec. E.164.

This field shall be absent if the national destination code does not exist, if it is not an e164 type communication address or if the communications address is not to be disclosed.

10.3.5.3 Subscriber's number

In version 1, this field is called **subscriberNumber**, while in version 2, it is called **commAddress**.

This field is used for holding a communications address (telephone number, e-mail address, URL, etc)

This field shall be present when a subscriber is found. Otherwise, it shall be absent.

An ITU-T Rec. E.164 number shall not include a possible national destination code.

If the communications address may be disclosed, it shall be formatted according to the type of communications address.

The type of communications address may be signalled in the **supplementaryData** field (see 10.3.5.9).

If the number is not to be disclosed, this field shall be filled with one or more capital 'X' characters.

10.3.5.4 Locality

This field holds the location under which the subscriber has been found or a locality to be returned within a **localityList** or a **streetList**.

A postal code may be returned together with the name of locality as follows:

- If a locality list is returned and the postal code is necessary to make the locality unambiguous, then the postal code shall be placed in front of the locality name separated with a single space.

NOTE – If the postal code is not necessary for making locality unambiguous, then the postal code may be placed in the **supplementaryData** field.

- If a subscriber list is returned, the postal code, if included, shall be placed in front of the locality name separated by a single space.

If none of the list types mentioned in 8.5 is eligible for return, then:

- if the **locality** field was present in the inquiry, this field shall echo that field,
- if the **locality** field was not present in the inquiry, this field shall be absent.

When returning a **localityList**, the locality name may optionally be followed by a number sign, but it shall be followed by a number sign if it is needed in a follow-on inquiry to make the locality unambiguous.

A selection taken from the locality list and placed unchanged in the inquiry fields shall never result in a locality list as an answer.

10.3.5.5 Subscriber name

Subscriber name is either surname or trade name of the subscriber.

If a list other than a **subscriberList** is returned, this field shall be absent.

Some countries require the introduction of an additional family name. When relevant, this additional family name shall be entered as follows:

The second family name shall be included in the **subscriberName** field. It shall follow the subscriber name, if any, and it shall be preceded by an equal sign. There shall be no spaces before and after the equal sign.

If none of the list types mentioned in 8.5 is eligible for return, then:

- if the **subscriberName** field was present in the inquiry, this field shall echo that field,
- if the **subscriberName** field was not present in the inquiry, this field shall be absent.

The support for second family name is mandatory.

10.3.5.6 Forename

This field, when present, holds the subscriber's forename.

If a list other than a **subscriberList** is returned, this field shall be absent.

For version 1 only: If none of the list types mentioned in 8.5 is eligible for return, then:

- if the **forename** field was present in the inquiry, this field shall echo that field,
- if the **forename** field was not present in the inquiry, this field shall be absent.

10.3.5.7 Name of street or equivalent

This field, when present, holds the name of street or equivalent.

If a list other than a **subscriberList** or **streetList** is returned, this field shall be absent.

If none of the list types mentioned in 8.5 is eligible for return, then:

- if the **streetName** field was present in the inquiry, this field shall echo that field,
- if the **streetName** field was not present in the inquiry, this field shall be absent.

10.3.5.8 House number

This field identifies a house within a street. A possible numerical part of the house number shall precede the possible alphabetical part without separation. Non-significant zeros shall be omitted.

If a list other than a **subscriberList** is returned, this field shall be absent.

If none of the list types mentioned in 8.5 is eligible for return, then:

- if the **houseNumber** field was present in the inquiry, this field shall echo that field,
- if the **houseNumber** field was not present in the inquiry, this field shall be absent.

10.3.5.9 Supplementary data

If this field is present when returning a **subscriberList**, it holds supplementary information about the subscriber.

If this field is present when returning a **localityList**, it holds supplementary information about the locality.

If this field is present when returning a **businessCategoryList** it holds supplementary information about the business category such as a more general business area description field to which the business category returned belongs. (for information and display only)

When descriptive keywords (see 9.6) are to be returned, they shall be returned within this field: If there are multiple keywords included, they shall be separated by a single space.

Only standardised descriptive keywords are allowed within this field.

As discussed in 10.3.5.4, when returning a **localityList** a postal code may be returned in this field if it is considered just supplementary information.

10.3.5.10 Subscriber message

This optional field holds a coded message, which should be converted into text by the inquiring system.

The following codes are defined:

- 0 = no comment;
- 1 = subscriber changed address;
- 2 = refer to distant operator;
- 3 = message in freeform text giving additional information about the subscriber and to be included in this field separated by one space from the code.

10.3.5.11 Heading in the guide

The semantics of this field is described in 10.2.4.6.

This field shall be used for holding business category when relevant for a subscriber in a **subscriberList** and when returning a **businessCategoryList**.

If a list other than a **subscriberList** or **businessCategoryList** is returned, this field shall be absent.

If none of the list types mentioned in 8.5 is eligible for return, then:

- if the **headingInTheGuide** field was present in the inquiry, this field shall echo that field,
- if the **headingInTheGuide** field was not present in the inquiry, this field shall be absent.

10.3.4.12 Profession code

This field, when present, specifies for a residential subscriber the profession, job (or academic title).

If a list other than a **subscriberList** is returned, this field shall be absent.

If none of the list types mentioned in 8.5 is eligible for return, then:

- if the **professionCode** field was present in the inquiry, this field shall echo that field,
- if the **professionCode** field was not present in the inquiry, this field shall be absent.

10.3.4.13 Additional information for a selective search

Information as specified by each service provider in the Operator Manual.

If none of the list types mentioned in 8.5 is eligible for return, then:

- if the **additionalInformationForASelectiveSearch** field was present in the inquiry, this field shall echo that field,
- if the **additionalInformationForASelectiveSearch** field was not present in the inquiry, this field shall be absent.

10.3.4.14 County, State or Province

This optional field holds County, State or Province name.

If a **businessCategoryList** is returned, this field shall be absent.

If none of the list types mentioned in 8.5 is eligible for return, then:

- if the **countyStateOrProvince** field was present in the inquiry, this field shall echo that field,
- if the **countyStateOrProvince** field was not present in the inquiry, this field shall be absent.

10.3.4.15 Category

This optional field may supply information about the subscriber category. If a list other than a **subscriberList** is returned, this field shall be absent.

One and only one of the following upper case codes shall be placed in this field: **B** for Business, **R** for Residential and **G** for Government.

If none of the list types mentioned in 8.5 is eligible for return, then:

- if the **category** field was present in the inquiry, this field shall echo that field,
- if the **category** field was not present in the inquiry, this field shall be absent.

10.3.4.14 Subscriber description

This optional field is used for providing additional information about the subscriber in free text (e.g. "Open 24/24 hours").

This field shall be absent for other than a **subscriberList**.

This field shall be absent unless there exists a bilateral agreement on its use.

11 Version 2 of the Directory Assistance protocol specification

11.1 Overview

A DA transaction consists of an inquiry and a reply. The format of the inquiry is shown in Figure 7/E.115. The details are given in 11.2. The format of the reply is shown in Figure 9/E.115. The details are given in 11.3.

Several transactions may be in progress simultaneously on the same connection between an inquiring system and a replying system. Replies may come back in a different order than the order of inquiries. The originating terminal code field (see 11.2.3.1) is used for paring inquiries and replies.

11.2 Inquiry format

11.2.1 Structure of the inquiry

The structure of an inquiry for version 2 is shown in Figure 7/E.115. It reflects the information as entered by an operator (or user) and formatted by the inquiring system. The information is used by the replying system to search the database for listings that match the inquiry.

Inquiry header								
Originating terminal code	Date and time	Message number	Country name	Provider code	Inquiry character set	Reply character set	Requested reply type	Accepted reply types

Inquiry data								
locality	Subscriber name	Street name or equivalent	House number	Forename	Heading in the guide	Profession code	County, State or Province	Category

Inquiry data (cont.)							
Sequence number	Postal code	National destination code	Communications address	Communication address types	Additional name	Communication address service	Communication address characteristics

Inquiry data (end)								
Geographical expansion	Search coordinates						Matching rules	Maximum selection level
	Search radius	Latitude	Longitude	Geodetic datum	Projection	Geographical type		

FIGURE 8/E.115

Inquiry format for version 2

The different fields of the inquiry for version 2 are described in 11.2.3 and 11.2.4.

11.2.2 Inquiry field lengths

Table 5/E.115 lists the inquiry field length in characters of the different fields. Some fields have a fixed length, while other fields have variable length with a specified maximum length. A compliant implementation shall be able to receive inquiry messages up to the maximum or fixed length.

TABLE 5/E.115

Field	Length	
originatingTerminalCode	Exact 8	I n q u i r y h e a d e r
dateAndTime	Exact 12	
messageNumber	Exact 4	
countryName	Exact 2	
providerCode	Exact 3	
inquiryCharacterSet	Determined by enumerated values	
replyCharacterSet	Determined by enumerated values	
requestedReplyType	Determined by enumerated values	
acceptedReplyTypes ¹	Determined by included subfields	
locality	Max. 256	I n q u i r y d a t a
subscriberName	Max. 256	
streetName	Max. 256	
houseNumber	Max. 256	
forename	Max. 256	
headingInTheGuide	Max. 256	
professionCode	Max. 256	
countyStateOrProvince	Max. 256	
category	Determined by included subfields	
sequenceNumber	Max. 2	
postalCode	Max. 256	
nationalDestinationCode	Max. 14	
commAddress	Max. 256	
commAddressTypes	Determined by included subfields	
additionalName	Max. 256	
commAddressService	Determined by included subfields	

TABLE 5/E.115 (completed)

Field		Length	
commAddressChar		Determined by included susfields	I n q u i r y d a t a
geoExpansion		Max. 3	
searchCoordinate	searchRadius	Max. 9	
	latitude	?	
	longitude	?	
	geodeticDatum	?	
	projection	?	
	geographical	Exact 3	
matchingRule		Determined by included subfields	
maxSelectionLevel		Max. 3	

11.2.3 Inquiry header

11.2.3.1 Originating terminal code

This mandatory field holds a value generated by the inquiring system. The replying system shall echo this value in the reply (see 11.3.3.1).

This field allows an inquiring system to pair a reply with the corresponding inquiry and thereby route the reply back to the source of the inquiry, e.g. a particular workstation.

An inquiring system implementation shall ensure that it does not issue an inquiry with the same value as for an outstanding inquiry against a particular replying system.

If the length of the field is not exactly 8 characters, message code 22 shall be returned by the replying system.

11.2.3.2 Date and time

This optional field gives the date and time of the origin of the inquiry.

Format: YYMMDDHHMMSS

If this field is present, it shall be echoed unchanged by the replying system back to the inquiring system (see 11.3.3.2).

If the length of the field is not exactly 12 characters, message code 22 shall be returned by the replying system.

NOTE – This field has no significance for the search, so the replying system should not check the content of this field, only the length.

11.2.3.3 Message number

This optional field holds a message number generated by the inquiring system.

If this field is present, the content shall not be checked by the replying system, but shall be echoed unchanged back to the inquiring system (see 11.3.3.3).

If the length of the field is not exactly 4 characters, message code 22 shall be returned by the replying system.

11.2.3.4 Country name

This field shall always present. The value shall be the country name of the system intended to process the inquiry and it shall consist of two characters as defined by ISO 3166.

NOTE – ISO 3166 uses the term country code, but the ITU-T Rec. E.164 uses the same term for a data type having a different syntax. To avoid confusion, the ISO 3166 country code is here called country name.

This field is used together with the **providerCode** field, if present, to determine the DA system that is intended to process the inquiry. If the identified DA system is different from the recipient DA system, the recipient DA system shall forward the inquiry to the intended DA system if possible.

11.2.3.5 Provider code

This field shall be present if the **countryName** alone is not sufficient to identify a particular DA system.

The value shall be the code for service provider managing the system intended to process the inquiry and it shall consist of three characters. Creation, maintenance and access to such a list are by means outside this Recommendation.

11.2.3.6 Inquiry character set

This field indicates what character repertoire of ISO/IEC 10646 is used for the inquiry. It can take one of two values:

- a) **basic**, which means that only the basic subset as defined in 9.1.3 is used; or
- b) **latin1**, which means that the LATIN-1 SUPPLEMENT repertoire is used in addition to the **basic** repertoire.

If this field is absent, it defaults to **basic**.

11.2.3.7 Reply character set

This field indicates what character repertoire of ISO/IEC 10646 the inquiring systems wants the replying system to use for the reply. It can take one of two values:

- a) **basic**, which means that only the basic subset as defined in 9.1.3 shall be used; or
- b) **latin1**, which means that the LATIN-1 SUPPLEMENT repertoire is requested to be used in addition to the **basic** repertoire.

If this field is absent, it defaults to **latin1**.

11.2.3.8 Requested reply type

This optional field indicates what selection list type (reply type) the requester is expecting. If present, one and only one of the following reply types shall be specified:

- a) **subscriberList**
- b) **localityList**;
- c) **businessCategoryList**;
- d) **streetList**; or
- e) **provinceList**.

If this field is absent, it defaults to **subscriberList**.

It is a local decision which search filter items apply to each type of list. The typical cases are:

- a) **localityList**:
 - **nationalDestinationCode**;
 - **countyStateOrProvince**;
 - **locality**;
 - **postalCode**.
- b) **streetList**:
 - **streetName**.
- c) **businessCategoryList**:
 - **headingInTheGuide**

- d) **provinceList**:
 - **countyStateOrProvince**

11.2.3.9 Accepted reply types

This field has subfields indicating the types of accepted reply types (see below). A subfield, when present, shall always in ASN.1 encoding have the value **TRUE**. When using XML encoding, each subfield is represented by an XML attribute of the **acceptedReplyTypes** empty element, and shall, if present, always have the value **true**.

If an inquiring system indicates a type of list in the **acceptedReplyTypes**, it is to be interpreted, that the inquiring system accepts receiving this type of list, if the values in the corresponding search filter items would result in more than one selection in this list. If several list types are indicated, it is a local decision as to which type of list to return.

If this field is present, one or more of the following subfields shall be supplied:

- a) **localityList**;
- b) **businessCategoryList**;
- c) **streetList**; and
- d) **provinceList**.

If the requested reply type cannot be returned and this field is absent or the replying system does not support the relevant reply type, the replying system shall issue the appropriate message code.

A replying system shall not return a list type not specified in either **requestedReplyType** or **acceptedReplyTypes**.

11.2.4 Inquiry data

11.2.4.1 Locality

The name of the locality shall be introduced according to its exact spelling.

Abbreviations are not permitted, except for the words “Sint”, “Saint”, “Sankt”, “San”, ..., which are abbreviated by the letter “S” followed by a space.

The locality name and county, state or province name (if supported) may be truncated. If this combination, when a search for subscribers is requested, matches more than one locality, a **localityList** shall be returned, unless a multiple location search is performed as specified in 8.5, in which case a **subscriberList** may be returned..

If the locality information identifies a single locality, the subscriber search shall be performed.

The mandatory minimum number of characters to be input should be fixed by each service provider and be mentioned in an Operator Manual. The inquiring system should check whether this minimum is respected.

When a word is terminated by a full stop this implies that the word is complete, when a word is not terminated by a full stop this implies that the word might be either complete or not complete. When a specification consists of more than one word, the full stop is additional to the separating space. (DEN HAAG would be specified as “DEN.□HAAG” and not “DEN.HAAG”, the □ is supposed to represent a blank).

The matching to be performed will be the following:

- words in the name may be truncated (may even be empty);
- completeness of a word may be indicated by a full stop that follows the word;
- absence of the above-mentioned full stop does not imply that the word is not complete.

To indicate that the number of words in the inquiry is complete, the character “#” may be used, and it shall then be inserted at the end of the field. Absence of the character “#” does not imply that not all words are present. If both the full stop, to indicate that the last word is complete, and the number sign are present, the full stop shall precede the number sign.

If the **countyStateOrProvince** field is present and the **locality** field does not specify a location within that area, then message code 64 shall be returned, with the exception as listed below for the protocol version specific considerations.

If the locality given is not part of the county, state or province given, but is part of another county, state or province, and the **acceptedReplyTypes** specifies **localityList**, then the replying system may optionally return a **localityList** with this other county, state or province name together with the locality name.

11.2.4.2 Subscriber name

Subscriber name is either surname or trade name of the subscriber.

The subscriber's surname should be input according to its exact spelling.

Abbreviations should not be allowed. The mandatory minimum number of characters to be input should be fixed by each service provider and be mentioned in the Operator Manual.

The replying system should check whether this minimum is respected. When a word is terminated by a full stop this implies that the word is complete, when a word is not terminated by a full stop this implies that the word might be either complete or not complete. When a specification consists of more than one word, the full stop is additional to the separating space.

When the subscriber's surname or trade name is replaced by initials, the characters composing the acronym shall be introduced successively without being separated by special signs or spaces.

NOTE 1 – Special signs are characters of the repertoire defined in 9.1.1 with the exception of the 26 small and 26 capital letters (a-z and A-Z) and the figures 0-9.

NOTE 2 – As examples, C&A or C & A shall be transmitted as CA and F.N.C.B. shall be transmitted as FNCB.

It is recommended to add the full stop when the acronym or abbreviation is fully specified (example: NATO.).

Numbers forming part of names or acronyms shall be introduced as numeric characters.

11.2.4.3 Name of street or equivalent

The name of the street shall be input according to its exact spelling.

The words "Sint", "Saint", "Sankt", "San", ... should be abbreviated by the letter "S" followed by a space. The mandatory minimum number of characters to be input should be fixed by each service provider and be mentioned in the operator's manual. The inquiring system should check whether this minimum is respected. When a word is terminated by a full stop this implies that the word is complete, when a word is not terminated by a full stop this implies that the word might be either complete or not complete. When a specification consists of more than one word, the full stop is additional to the separating space. Numbers forming part of the name of the street shall be introduced as numeric characters.

11.2.4.4 House number

This field identifies a house within a street. A possible numerical part of the house number shall precede the possible alphabetical part without separation. Non-significant zeros shall be omitted.

11.2.4.5 Subscriber's forename

Entire forenames, initials or a combination of forenames and initials shall always be separated by spaces.

11.2.4.6 Heading in the guide

This field shall be used for holding the business category when relevant. When this field is present, it acts as a filter item.

The business category describes for a business, institutional or government subscriber, the activity domain in which the business, institution or administrative authority is involved.

NACE codes may be used to refer to business categories to surmount language problems (see Annex F).

It may be a general category, e.g. Telecommunications, Administrations, or a more specific activity, e.g. Telecommunication mobile telephony, Railways.

For an example, see 10.2.4.6:

11.2.4.7 Profession code

This optional field shall not be present for other than residential subscribers.

This field, when present, specifies for a residential subscriber the profession, job (or academic title) and acts as a filter item.

11.2.4.8 County, State or Province

The matching to be performed will be the following:

- word in the name can be truncated (can even be empty);
- completeness of a word can be indicated by a full stop that follows the word;
- absence of the above-mentioned full stop does not imply the word is not complete.

11.2.4.9 Category

This optional field may supply information about the subscriber category.

This field has subfields indicating types of subscriber categories (see below). A subfield, when present, shall always in ASN.1 encoding have the value **TRUE**. When using XML encoding, each subfield is represented by an XML attribute of the **category** empty element, and shall, if present, always have the value **true**.

When present, one or more of the following subfields shall be supplied:

- a) **business**: When present, only listings of this category shall be considered for selection;
- b) **residential**: When present, only listings of this category shall be considered for selection;
- c) **government**: When present, only listings of this category shall be considered for selection.

When present, this field shall be treated as a filter item. If several subfields are present, they shall individually be matched against listings and the results shall be logical OR'ed.

Not all replying system may support all the categories. If only one subfield is included, and this category is not supported, the replying system shall return message code 40 (Required Service not Supported). If several subfields are supplied and the replying system support some, but not all the specified categories, then it is a local option by the replying system whether to ignore the unsupported categories and apply only the supported ones or whether to return message code 40.

11.2.4.10 Sequence number

The sequence number indicates which page of the reply shall be sent (see 9.4). The number 0 (zero) (or if the field is omitted) indicates the first page, the number 1 the second page, etc. This number shall not be greater than 9. The sequence number shall be sent a single numeric character.

NOTE – The sequence number field is in the formal AS:1 and XSD specification defined as having a length of one or two numeric characters to cope with possible future extensions.

11.2.4.11 Postal code

This optional field acts as a filter item to narrow the search.

11.2.4.12 National Destination Code

This optional field acts as a filter item to narrow the search.

If present, it shall hold the telephone National Destination Code as defined by ITU-T Rec. E.164.

11.2.4.13 Communications Address

This field shall be present if the inquiring system wants to perform a reverse search based on a particular communications address. If it is an ITU-T Rec. E.164 number, it shall be the complete national number, including a possible National Destination Code, but excluding country code.

NOTE – A reverse search is a search where the communications address is known and the corresponding subscriber identity is searched.

The type of communications address shall be signalled in the **commAddressType** field (see 11.2.4.14).

If the search is performed, but no subscriber is found, the message code 92 shall be returned.

In case the replying system does not either support reverse search, in general or for the specific communications address type, the replying system shall return a message-code 43 or 44, depending on whether the replying system does not support the type of search for this particular inquiring system or does not support the type of search at all.

11.2.4.14 Communications address types

This field has subfields indicating the types of communications addresses (see below). A subfield, when present, shall in ASN.1 encoding always have the value **TRUE**. When using XML encoding (using either the Annex C specification with ASN.1/XER, or the Annex D XSD specification), each subfield is represented by an XML attribute of the **commAddressTypes** empty element, and shall, if present, always have the value **true**.

When a communications address is supplied in the **commAddress** field, this field shall be present and hold one and only one subfield indicating the type of communications address (see below) that has been supplied in the **commAddress** field.

When a communications address is not supplied in the **commAddress** field, this field is optional. When present, one or more of the following subfields shall be supplied:

- a) **e164**: When present, listings holding an ITU-T Rec. E.164 type communications address shall be considered for selection;
- b) **rfc822**: When present, listings holding an RFC 822 type communications address (e-mail address) shall be considered for selection. The @ in the address shall be replaced with (a).

NOTE – As indicated in 9.1.1, there is a preference to use @ if the replying system supports it.

- c) **rfc1738**: When present, listings holding an RFC 1738 type communications address (URL) shall be considered for selection.

When present, this field shall be treated as a filter item. If several subfields are present, they shall individually be matched against listings and the results shall be logical OR'ed.

11.2.4.15 Additional naming information

Some countries require the introduction of an additional family name (e.g. second family name, grandfather name, etc.

When an additional family name is to be included as a filter item, it shall be supplied in this field (without the equal sign as for version 1).

This field may also be used for other naming information relevant for countries or cultures.

The specific use of this field shall be specified in the Operator Manual.

11.2.4.16 Communications address service

This optional field specifies requirements on the type of service to be accessed through the communications address for returned subscriber selections. This field has subfields indicating types of communication address service (see below). A subfield, when present, shall in ASN.1 encoding always have the value **TRUE**. When using XML encoding, each subfield is represented by an XML attribute of the **commAddressService** empty element, and shall, if present, always have the value **true**.

When present, one or more of the following subfields shall be supplied:

- a) **fax**: Only listings holding a communications address that support fax shall be considered for selection;
- b) **pbx**: Only listings holding a communications address of a PBX shall be considered for selection. This subfield shall not be included unless the **commAddressType** is **e164**;
- c) **txt**: Only listings holding a communications address for a text telephone shall be considered for selection. This subfield shall not be included unless the **commAddressType** is **e164**;
- d) **pub**: Only listings holding a communications address for public telephone shall be considered for selection; This subfield shall not be included unless the **commAddressType** is **e164**;
- e) **vid**: Only listings holding a communications address for video telephone shall be considered for selection;
- f) **pag**: Only listings holding a communications address of a pager shall be considered for selection; This subfield shall not be included unless the **commAddressType** is **e164**;
- g) **voice**: Only listings holding a communications address that supports voice communication shall be considered for selection;
- h) **data**: Only listings holding a communications address that supports data transmission shall be considered for selection;

- i) **http**: Only listings holding a communications address that supports HTTP communication shall be considered for selection;
- j) **ftp**: Only listings holding a communications address that supports FTP communication shall be considered for selection;
- k) **eml**: Only listings holding a communications address that supports e-mail communication shall be considered for selection;
- l) **sms**: Only listings holding a communications address that supports SMS communication shall be considered for selection;
- m) **mms**: Only listings holding a communications address that supports MMS communication shall be considered for selection.
- n) **emg**: Only listings holding a communications address that supports emergency messages shall be considered for selection.

When present, this field shall be treated as a filter item. If several subfields are included, they shall individually be matched against a particular listing and the results shall be logical OR'ed.

11.2.4.17 Communications address characteristics

This optional field specifies requirements on the type of characteristics associated with the communications address for returned subscriber selections. This field has subfields indicating types of communication address characteristics (see below). A subfield, when present, shall in ASN.1 encoding always have the value **TRUE**. When using XML encoding, each subfield is represented by an XML attribute of the **commAddressChar** empty element, and shall, if present, always have the value **true**.

When present, one or more of the following subfields shall be supplied:

- a) **ftn**: Only listings holding an **e164** communications address that has a free tax number shall be considered for selection.
- b) **mob**: Only listings holding a communications address for a mobile device shall be considered for selection.
- c) **fixed**: Only listings holding a communications address for a fixed device shall be considered for selection.

When present, this field shall be treated as a filter item. If several subfields are included, they shall individually be matched against listings and the results shall be logical OR'ed.

11.2.4.18 Geographical expansion

This field, when present, shall hold a numeric character indicating the level of geographical extension. A higher number implies a higher degree of expansion. The actual mapping is determined locally by the replying system.

NOTE – Information about the expansion policy should be described in the Operator Manual.

11.2.4.19 Search coordinate

This optional field is used when performing a proximity search.

This field specifies the coordinates of the center for the proximity search.

This field has the following subfields:

- a) **searchRadius** - This optional subfield shall be encoded as a character-encoded number that specifies the radius of a proximity search. The mapping of the number to a real distance is service provider dependent and shall be specified in the Operator Manual. When using XML encoding, this subfield is an XML attribute of the **searchCoordinate** element.
- b) **latitude** – This mandatory subfield gives the latitude of the location using the syntax specified by the geographical subfield. When using XML encoding, this subfield is a child element of the **searchCoordinate** element.
- c) **longitude** – This mandatory subfield gives the longitude of the location using the syntax specified by the geographical subfield. When using XML encoding, this subfield is a child element of the **searchCoordinate** element.

- d) **geodeticDatum** – This optional subfield specifies the type of coordinate system in which the **latitude** and **longitude** are expressed. When using XML encoding, this subfield is an XML attributes of the **searchCoordinate** element.
- e) **projection** – This optional subfield specifies the technique used to represent the spherical (or ellipsoidal) image in a flat display. When using XML encoding, this subfield is an XML attributes of the **searchCoordinate** element.
- f) **geographical** – This subfield gives the syntax of the coordinates given for the **latitude** and **longitude** subfields. When using XML encoding, this subfield is an XML attributes of the **searchCoordinate** element. It may take one the following values:
 - **dms**, which means that the coordinates are given in the degrees-minutes-seconds format; or
 - **dec** (default value), which means that the coordinates are given in degrees as a decimal figure.

11.2.4.20 Matching rules

This optional field is used by the inquiring system to ask for particular matching behaviour instead of the default matching performed by the replying system.

This field, when present, shall have one or more of the following Boolean subfields:

- a) **wordRotation**: If it is **TRUE** in ASN.1 encoding or **true** in XML encoding, it indicates that the words in some filter items of the inquiry may not be supplied in the right order and the replying system should use word rotation matching for relevant filter items. If it is **FALSE** in ASN.1 encoding or **false** in XML encoding, word rotation shall not be performed on any filter item. If this subfield is absent, it is a local decision by the replying system whether to perform word rotation matching.
- b) **phonetic**: If it is **TRUE** in ASN.1 encoding or **true** in XML encoding, it indicates that some filter items of the inquiry may not have the exact spelling, but might be spelled according to their pronunciation and that the replying system should perform phonetic matching for relevant filter items. If it is **FALSE** in ASN.1 encoding or **false** in XML encoding, phonetic matching shall not be performed on any filter item. If this subfield is absent, it is a local decision by the replying system whether to perform phonetic matching.
- c) **alias**: Some filter items of an inquiry may have a value that does not match any value within the database of a replying system, but a synonym of that value might match. This may in particular be the case for **businessCategories**, where there may be different synonyms for particular business categories. As an example, coiffeur and hairdresser are synonyms for the same business category. If this subfield is **TRUE** in ASN.1 encoding or **true** in XML encoding, it indicates that the replying systems should apply alias matching, that it, should try to use synonyms for relevant fields. If it is **FALSE** in ASN.1 encoding or **false** in XML encoding, alias matching shall not be performed on any filter item. If this subfield is absent, it is a local decision by the replying system whether to perform alias matching.

When using XML encoding, these subfields are represented by XML attributes of the **matchingRule** empty-element.

11.2.4.21 Maximum selection level

This optional field allows the inquiring system to specify the maximum level of grouped listings to be searched and from which selections are to be returned.

The value is specified as a numeric character, where level "0" is the top level.

The default value is "99"

11.3 Reply format

11.3.1 Structure of the reply

The structures of a reply for version 2 is shown in Figure 9/E.115. It reflects the information returned by a replying system. If relevant, this information is assumed to be converted by the inquiring system into a format suitable for the presentation at the workstation.

If the amount of information to be returned is substantial, the replying system shall split selections into pages as discussed in 9.4.

Reply header						
Originating terminal code	Date and time	Message number	Message code	Message	DB Selection count	Reply character set

Selection 1							
National destination code	Communications address	locality	Subscriber name	Forename	Street name or equivalent	House number	Supplementary data

Selection 1 (cont.)							
Subscriber message	Heading in the guide	Profession code	County, State or Province	Category	Country code	Postal code	Communication address type

Selection 1 (cont.)								
Communication address service	Communication address characteristics	Distance	Additional name	Selection coordinates				
				Latitude	Longitude	Geodetic datum	Projection	Geographical type

Selection 1(end)	Selection 2	Selection 3	● ● ●	Selection n
Selection level				

FIGURE 9/E.115

International reply format for version 2

The different fields of the reply for version 2 are described in 11.3.3 and 11.3.4.

11.3.2 Field lengths of reply

Table 6/E.115 lists the different fields with length requirements in characters. For variable length fields the maximum field length is given. A compliant implementation shall be able to receive reply messages up to the maximum length.

TABLE 6/E.115

Field	Length	
Originating terminal code	Exact 8	R e p l y h e a d e r
Date and time	Exact 12	
Message number	Exact 4	
Message code	Exact 2	
Country code 1)	N/A	
Message	Max. 256	
dbSelectionCount	Max. 10	
replyCharacterSet	Determined by enumerated values	
National destination code	Max. 14	S e l e c t i o n
Communications address	Max. 256	
Locality	Max. 256	
Surname or trade name of subscriber	Max. 256	
Subscriber's forename	Max. 256	
Name of street or equivalent	Max. 256	
House number	Max. 256	
Supplementary data	Max. 256	
Subscriber message	Max. 256	
Heading in the guide	Max. 256	
Profession code	Max. 256	
County, State or Province	Max. 256	
subscriberDescription	Max. 256	
Category	Determined by included subfields	
countryCode	Max. 3	
postalCode	Max. 256	
commAddressType	Determined by enumerated values	
commAddressService	Determined by included subfields	

TABLE 6/E.115 (Continued)

Field		Length	
commAddressChar		Determined by included subfields	S e l e c t i o n
distance		Max. 256	
searchCenter		Max. 256	
additionalName		Max. 256	
selectionCoordinate	latitude	?	
	longitute	?	
	geodeticDatum	?	
	projection	?	
	geographical	Exact 3	
selectionLevel		Max. 3	

11.3.3 Reply header

This part of the reply holds general information not directly related to the individual returned selections (if any).

11.3.3.1 Originating terminal code

This mandatory field shall echo the corresponding field of the inquiry (see 11.2.3.1).

11.3.3.2 Date and time

If the corresponding field is present in the inquiry (see 11.2.3.2), this field shall echo the date and time as generated by the inquiring system. Otherwise, this field shall be absent.

11.3.3.3 Message number

If the corresponding field is present in the inquiry (see 11.2.3.3), this field shall echo the message number as generated by the inquiring system. Otherwise, this field shall be absent.

11.3.3.4 Message code

This mandatory field signals the outcome of the inquiry. The message codes are defined in Annex E.

NOTE – If the user is a human being, it is assumed that the inquiring system will convert the message code to a text message.

11.3.3.5 Message

This field should only be used for urgent messages, for example to announce short interruptions that cannot be announced in time in ways normally agreed upon among service providers.

It shall be sent with every reply as long as it is relevant, but not for more than 5 minutes.

It is a free text field. The message shall be in the English language.

The following are examples of urgent messages:

System will be down from date/time GMT until date/time GMT

System will be down from date/time GMT for about 10 minutes

11.3.3.6 DB selection count

This optional field provides a figure that indicates the number of selections that have been found by the replying system. If this figure is prefixed a greater-than sign (>) it indicates that the number of selections exceeds this figure.

When using version 1 of this protocol, this field shall not be included unless there exists a bilateral agreement on its use.

11.3.3.7 Reply character set

This field indicates what character repertoire of ISO/IEC 10646 is used for the reply.

If this field is absent, the character repertoire used is the one implicitly or explicitly requested by the inquiring system (see 11.2.3.7). If present, it shall take one of two values:

- a) **basic**, which means that only the basic subset as defined in 9.1.3 is used; or
- b) **latin1**, which means that the LATIN-1 SUPPLEMENT repertoire is used in addition to the **basic** repertoire. This value shall not be specified unless, the inquiring system requested **latin1** (possibly by default).

11.3.4 Selections

11.3.4.1 Structure of selections

If no selection was found to be returned, then selections shall be absent.

If several communications addresses are to be returned for a given subscriber, then a selection shall be returned for each communications address.

11.3.4.2 National destination code

This field shall be present when a national destination code exists, a subscriber is found, it is an **e164** type communication address and the subscriber's number may be disclosed. It shall be formatted as defined by ITU-T Rec. E.164.

This field shall be absent if the national destination code does not exist, if it is not an e164 type communication address or if the communications address is not to be disclosed.

11.3.4.3 Communications address

This field is used for holding a communications address (telephone number, e-mail address, URL, etc)

This field shall be present when a subscriber is found. Otherwise, it shall be absent.

An ITU-T Rec. E.164 number shall not include a possible national destination code.

If the communications address may be disclosed, it shall be formatted according to the type of communications address.

The type of communications address shall be signalled in the **commAddressType** field (see 11.3.4.18).

If the number is not to be disclosed, this field shall be filled with seven uppercase 'X' characters.

11.3.4.4 Locality

This field holds the location under which the subscriber has been found or a locality to be returned within a **localityList** or a **streetList**.

A postal code shall not be supplied in this field, but may be supplied in the **postalCode** field. (see 11.3.4.17).

When returning a **localityList**, the locality name may optionally be followed by a number sign, but it shall be followed by a number sign if it is needed in a follow-on inquiry to make the locality unambiguous.

A selection taken from the locality list and placed unchanged in the inquiry fields shall never result in a locality list as an answer.

11.3.4.5 Subscriber name

Subscriber name is either surname or trade name of the subscriber.

If a list other than a **subscriberList** is returned, this field shall be absent.

11.3.4.6 Forename

This field, when present, holds the subscriber's forename.

If a list other than a **subscriberList** is returned, this field shall be absent.

11.3.4.7 Name of street or equivalent

This field, when present, holds the name of street or equivalent.

If a list other than a **subscriberList** or **streetList** is returned, this field shall be absent.

11.3.4.8 House number

This field identifies a house within a street. A possible numerical part of the house number shall precede the possible alphabetical part without separation. Non-significant zeros shall be omitted.

If a list other than a **subscriberList** is returned, this field shall be absent.

11.3.4.9 Supplementary data

If this field is present when returning a **subscriberList**, it holds supplementary information about the subscriber.

If this field is present when returning a **localityList**, it holds supplementary information about the locality.

If this field is present when returning a **businessCategoryList** it holds supplementary information about the business category such as a more general business area description field to which the business category returned belongs. (for information and display only)

11.3.4.10 Subscriber message

This optional field holds a coded message, which should be converted into text by the inquiring system.

The following codes are defined:

- 0 = no comment;
- 1 = subscriber changed address;
- 2 = refer to distant operator;
- 3 = message in freeform text giving additional information about the subscriber and to be included in this field separated by one space from the code.

11.3.4.11 Heading in the guide

The semantics of this field is described in 11.2.4.6.

This field shall be used for holding business category when relevant for a subscriber in a **subscriberList** and when returning a **businessCategoryList**.

If a list other than a **subscriberList** or **businessCategoryList** is returned, this field shall be absent.

11.3.4.12 Profession code

This field, when present, specifies for a residential subscriber the profession, job (or academic title).

If a list other than a **subscriberList** is returned, this field shall be absent.

11.3.4.13 County, State or Province

This optional field holds County, State or Province name.

If a **businessCategoryList** is returned, this field shall be absent.

11.3.4.14 Subscriber description

This optional field is used for providing additional information about the subscriber in free text (e.g., "Open 24/24 hours").

This field shall be absent for other than a **subscriberList**.

11.3.4.15 Category

This optional field may supply information about the subscriber category (see below). If a list other than a **subscriberList** is returned, this field shall be absent.

A subfield, when present, shall in ASN.1 encoding always have the value **TRUE**. When using XML encoding, each subfield is represented by an XML attribute of the **category** empty element, and shall, if present, always have the value **true**.

When present, one or more of the following subfields shall be present:

- a) **business**: When present, it indicates that the selection is for a business subscriber;
- b) **residential**: When present, it indicates that the selection is for a residential subscriber;
- c) **government**: When present, it indicates that the selection is for a government subscriber.

11.3.4.16 Country code

This optional field shall hold the ITU-T Rec. 164 country code for the selection. It is mandatory for selections containing ITU-T Rec. E.164 address type.

11.3.4.17 Postal code

This optional field provides the postal code for selection.

If a list other than a **subscriberList**, a **localityList** and a **streetList** is returned, this field shall be absent.

11.3.4.18 Communications address type

This field shall be present if the **commAddress** field (see 11.3.4.3) holds a communications address that may be disclosed. Otherwise, this field shall be absent.

When present, this field shall hold one of the following values:

- a) **e164** when the returned communications address has syntax as defined by ITU-T Rec. E.164.
- b) **rfc822** when the returned communications address has syntax as defined by RFC 822 (e-mail address syntax). The **@** in the address shall be replaced with (a).
- c) **rfc1738** when the returned communications address has a syntax as defined by RFC 1738 (URL syntax).

11.3.4.19 Communication address services

This field shall be absent if the **commAddress** field (see 11.3.4.3) does not hold a communications address that may be disclosed.

This field has subfields indicating types of communication address services (see below) associated with the **commAddress**. A subfield, when present, shall in ASN.1 encoding always have the value **TRUE**. When using XML encoding, each subfield is represented by an XML attribute of the **commAddressService** empty element, and shall, if present, always have the value **true**.

This field indicates what service(s) can be obtained through the supplied communications address. When present, one or more of the following subfields shall be present:

- a) **fax** when a fax service can be obtained at the communications address.
- b) **pbx** when the communications address is for a PBX.
- c) **txt** when the communications address is for a text telephone.
- d) **pub** when the communications address is for a public telephone.
- e) **vid** when the communications address is for a video telephone.
- f) **pag** when the communications address is for a pager.
- g) **voice** when voice communications can be conducted through the communications address.
- h) **data** when data communications can be conducted through the communications address.
- i) **http** when HTTP type communications can be conducted through the communications address (e.g. Web services).
- j) **ftp** when the File Transfer Protocol (FTP) is supported through the communications address

- k) **eml** when e-mail service is supported through the communications address.
- l) **sms** when Short Messaging Service (SMS) is supported through the communications address.
- m) **mms** when Multimedia Message Service (MMS) supported through the communications address.
- n) **emg** when emergency messages are supported through the communications address.

11.3.4.20 Communications address characteristics

This field shall be absent if the **commAddress** field (see 11.3.4.3) does not hold a communications address that may be disclosed.

This field has subfields indicating communication address characteristics (see below). A subfield, when present, shall in ASN.1 encoding always have the value **TRUE**. When using XML encoding, each subfield is represented by XML attributes of the **commAddressChar** empty element, and shall, if present, always have the value **true**.

This field indicates what characteristics are associated with the communications address. When present, it shall include one or more of the following subfields:

- a) **ftn** when the communications address is a tax free telephone number.
- b) **mob** when the communications address is for a mobile telephone.
- c) **fixed** when the communications address is for a fixed line telephone.
- d) **prn** when the communications address is a premium rate telephone number.
- e) **npn** when the communications address is a personal country wide telephone number.
- f) **upn** when the communications address is a personal world wide number.
- g) **old** when the communications address has been valid, but now is obsolete.
- h) **adv** when the communications address comes from an advertising listing.
- i) **nmk** when the communications address shall not be used for marketing.

11.3.4.21 Distance

This field shall be present if a proximity search has been performed. Otherwise, it shall be absent. It gives the distance from the centre of the proximity search to this selections position.

The value shall be a character-encoded number. The mapping of the number to a real distance is service provider dependent and shall be specified in the Operator Manual.

11.3.4.22 Search center

This field shall be present if a proximity search has been performed. Otherwise, it shall be absent. It gives the coordinates for the center of the proximity search.

11.3.4.23 Additional naming information

When an additional family name is to be returned (see 11.2.4.15), it shall be supplied in this field (without the equal sign).

This field may also be used for returning other naming information relevant for countries or cultures.

The specific use of this field shall be specified in the Operator Manual.

The support for additional family name is mandatory.

11.3.4.24 Selection coordinates

This field gives the coordinates of the selection.

If the replying system has coordinates available within a selected listing, it should return them in the selection.

This field has the subfields **latitude**, **longitude**, **geodeticDatum**, **projection**, and **geographical** with the same meaning and encoding requirements as specified in 11.2.4.19.

11.3.4.25 Selection level

This field, if present, shall hold a number that indicates the level of the corresponding listing within a hierarchical group (see 9.5).

If this field is not present, it defaults to zero.

If a list other than a **subscriberList** is returned, this field shall be absent and its default shall be ignored.

12 TCP adaptation protocol

12.1 Introduction

The TCP adaptation protocol provides support for DA protocol version negotiation and for providing security in the form of authentication and encryption

12.2 Security

12.2.1 Authentication

The replying system may not know the socket of the inquiring system, and even if it does, the socket does not provide a secure identity, as it can easily be masqueraded by an outside party. The TCP adaptation protocol provides additional authentication through a negotiation procedure during the application connection establishment (see 12.3).

The authentication mechanism is based on the MD5 algorithm. This mechanism requires that both the inquiring and replying systems are agreeing on a common password.

The length of the password shall be minimum 6 characters and maximum 16 characters, where the characters shall be selected from the repertoire defined in 9.1.1.

This password must be kept in confidence. If this password is compromised by a third party obtaining it, the authentication mechanism is compromised. In particular, a replying system must rely on the inquiring system to protect the password.

The mechanism uses the four-way negotiation exchange detailed in 12.3.

- 1) After reception of the first message from the inquiring system, the replying system generates and sends a non-encrypted random number using numeric characters (arbitrary length and value).
- 2) The inquiring system concatenates the random number with the shared password (<random number><password>); and then by using the MD5 algorithm as defined by RFC 1321 it generates a 128 bit digest (fingerprint) and sends that back to the replying system.

Example: the bilateral agreed password is "345678". If the random number generated by the replying system is "8171", then the input of the MD5 message-digest algorithm is "8171345678" (38313731333435363738'H)

- 3) The replying system produces a 128-bit MD5 digest exactly as the inquiring system and compares that with the one received from the inquiring system. If it matches, authentication is completed and the connection it is assumed secure. Otherwise, the TCP connection shall be aborted.

The length of the password determines how much effort it takes to forge the password if the random number has been disclosed in some way.

The implementation and use of this authentication procedure is mandatory.

12.2.2 Encryption

Encryption is an optional facility. In cases where confidentiality is required the DA inquiries and replies may be encrypted. The RC4 encryption algorithm shall be used. The key to be used for encryption and decryption is generated by both the inquiring and replying system in the following way.

- 1) The password and random number used for the authentication procedure are concatenated, just now in reversed order (<password><random number>).
- 2) An MD5 digest is generated over the result of the concatenation. This 128 bit digest is used as the RC4 encryption key.

12.3 Application connection establishment

12.3.1 Message format and general procedure

A TCP connection (see 13.1) shall be established before an application connection can be established.

Application connection establishment involves a negotiation about the conduct of the application data exchange. This negotiation is based on the following “4-way-handshake” mechanism:

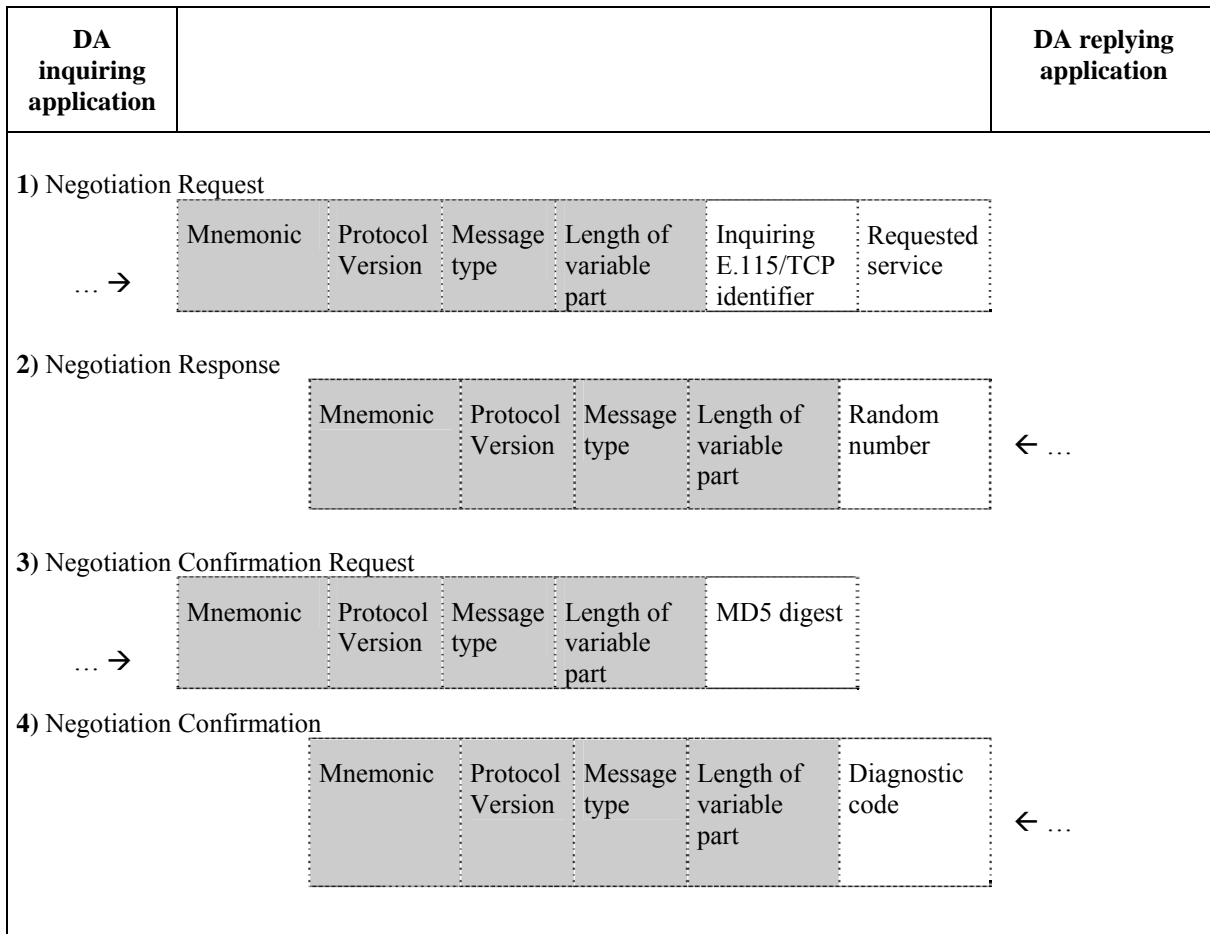

FIGURE 10/E.115

Application establishment exchange

If all stages of the above additional information interchange occurs correctly, the application connection is established and DA transactions (inquiry/reply) can be transmitted over the connection (see 11.4). Otherwise, the TCP connection is aborted after the last message exchange (stage 4), with reason for reset provided in the *Diagnostic code* field.

The inquiring system is not required to send inquiries right after the connection establishment. The normal inactivity timers shall be used (see 13.3.1).

To protect against missing negotiation messages, the systems shall after a time-out period close the TCP connection. This time-out shall be at least 1 second and not more than 20 seconds with a recommended value of 8 seconds.

If a connection establishment fails, the inquiring system should wait for a while before making a subsequent connection establishment attempt. At least one minute should elapse between each connection establishment attempt, but five minutes is the recommended wait-period.

12.3.2 Field descriptions

12.3.2.1 Fields common for all four message types

The fixed-length header contains four fields and is handled by the DA applications to determine Directory messages, protocol version, type of message and size of the variable part to be processed.

- a) *Mnemonic* – This field indicates that the Indicator identifying a message to the international inquiry service; 4 characters: Form: EIDQ

b) *Protocol Version* – identifies the DA protocol version to be used. It is a 4 character field and shall have one of the following values:

- 0100: DA protocol version 1
- 02rX: DA protocol version 2 using XML encoding
- 02rA: DA protocol version 2 using ASN.1 BER encoding

A replying system shall support version 1 and if a replying system supports version 2, it shall support the XML encoding and may optionally support the ASN.1 BER encoding.

There are two aspects of version negotiation, namely the major version negotiation and release negotiation (see 8.4). The major version negotiation principle is shown in Figure 11.

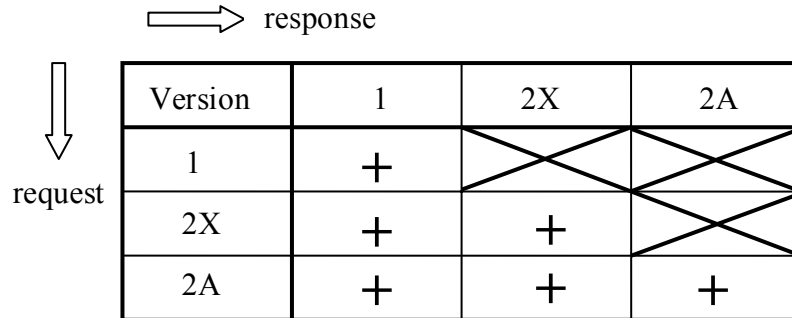

FIGURE 11/E.115

Version negotiation

- i) If the request specifies version 1, version 1 shall also be specified in the response. If the request specifies version 2 with XML encoding, version 1 or version 2 with XML shall be specified in the response. If the request specifies version 2 with ASN.1 BER encoding, any major version may be specified in the response.
- ii) If the inquiring system suggests version 2 (with XML or ASN.1 BER encoding) and the response also specifies version 2, then the release indicator in the response shall be equal or less than the one specified in the request. The inquiring system shall not use protocol elements that are not defined for the release specified in the response.

If the inquiring system does not accept the proposal from the replying system, it shall close the connection.

If the protocol version negotiation is successful, the protocol version field for all subsequent exchanges shall indicate the agreed protocol version.

c) *Message Type* – identifies the type of message; 2 characters:

- "Negotiation Request"; Form: NI
- "Negotiation Response"; Form: NR
- "Negotiation confirmation request"; Form: CI
- "Negotiation confirmation"; Form: CR

d) *Length of variable part* – identifies the length in octets of the directory message; encoded as an unsigned binary number within 2 octets, the left most bit of the field being the most significant bit. For instance 2612 will be encoded 0x0A 0x34.

An implementation shall check the correctness of this length field by comparing it with the actual length of the inquiry or reply. If the length field does not match that length, the connection shall be aborted.

12.3.2.2 Fields specific for Negotiation Request

The Negotiation Request has two specific fields for identification of the inquiring system and for a specification of the type of service wanted (requested service).

- a) *Inquiring system identifier* – 8 characters: aligned from the left (if necessary, padded with spaces)

The *Inquiring system identifier* field is used by the replying system to associate a connection to the inquiring system, manage the service specification associated, the billing aspects, etc. The value of this field is bilaterally agreed upon inquiring and replying service providers.

As an option, a cross check of this identifier against the calling TCP/IP address (when known) is sensible as extra check that this identifier is consistent with the network address of the inquiring DA system (see 12.1).

If the inquiring system identifier is invalid, the replying system shall close the connection.

- b) *Requested service* – 8 characters: aligned from the left (if necessary, supplemented by spaces)

The type of requested service is used to manage a more precise service specification for a given inquiring E.115/TCP application.

The following codes have been defined:

PUBLIC	Electronic directory service
OPERATOR	Directory assistance service
SECUREP	Secure Electronic directory service using encryption
SECUREO	Secure Directory assistance service using encryption

NOTE – New codes may be defined in the future

If the inquiring system specifies either an unknown requested service or a requested service it does not supported, the replying system shall close the connection.

12.3.2.3 Field specific for Negotiation Response

The replying system sends a Negotiation Response with a random number

The structure and coding of this information format use the following ASN.1-like notation:

1010 0000 (the "ASN.1" tag)

LENGTH of random number encoded as an unsigned binary number

Random number having a length of minimum 8 octets and maximum 100 octets, where each octet is coded as an unsigned number taking any value from 0 to 255.

12.3.2.4 Field specific for Negotiation Confirmation Request

The Negotiation Confirmation Request has one specific field. This field is used by the inquiring system to send an MD5 digest of the random number and password as discussed in 11.2.1

1010 0001 (the "ASN.1" tag)

LENGTH of MD5 digest encoded as unsigned binary number (always 16).

MD5 digest

When generating the MD5 digest, only the actual random number shall be used, i.e. the tag and the length fields are not included

12.3.2.5 Field specific for Negotiation Confirmation

The Negotiation Confirmation Request has one specific field. This field is used by replying system to return a two character diagnostic code indication the result of the negotiation,

The following codes have been defined:

- 00: negotiation accepted

- 10: invalid authentication or unknown DA system (access not permitted)
- 20: protocol error or protocol version not supported
- 30: lack of resources (too many connections established)
- 40: requested service not supported or not bilaterally agreed
- 50: system temporarily unavailable (added for version 2.0)

12.4 Application data transfer

When connection and negotiation phases occur correctly, transactions may be interchanged between the inquiring and system systems with the following formats:

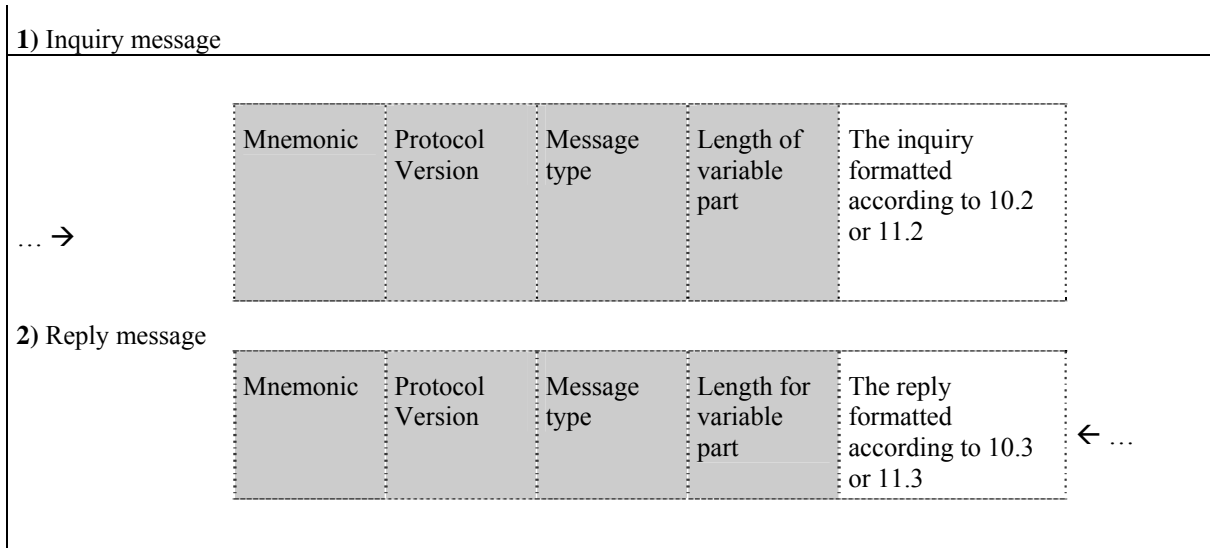

Or

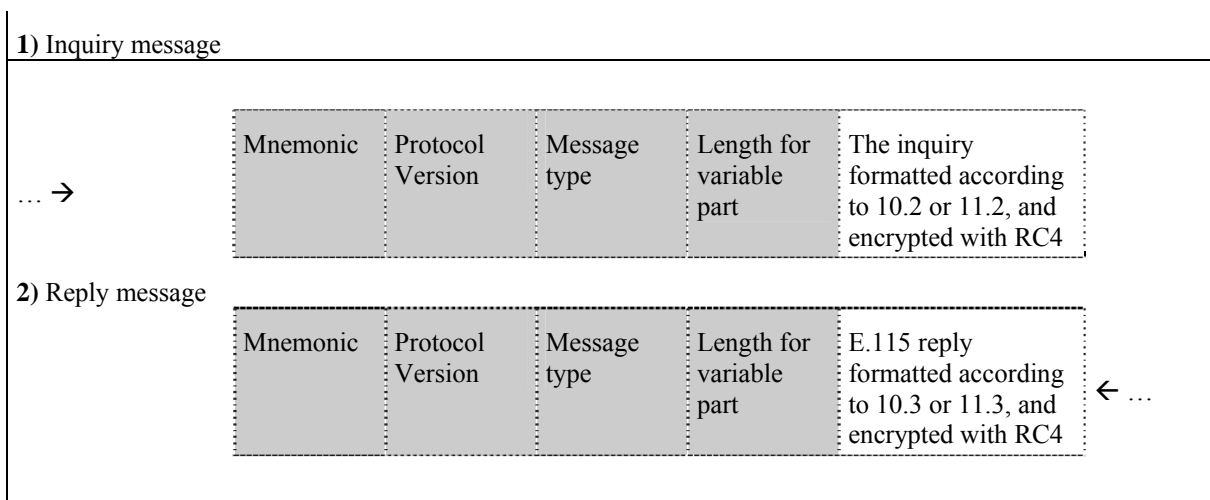

The fixed-length header contains two fields and is used by the DA applications to determine the beginning of the message and the size of the variable part to be processed.

- a) *Mnemonic* – A 4 character field identifying the variable part to be a message (inquiry or reply) formatted according to the DA protocol specification given in clause 10 or 11. This field shall be filled with the 4 characters: EIDQ.

- b) *Protocol Version* – A 4 character field identifies the DA protocol version used. It shall have the same value as negotiated during application connection establishment (see 12.3.2.1).
- c) *Message Type* – A 2 character field with the value "IM" if the variable field holds an inquiry and with the value "RM" if the variable field holds a reply:
 - 1)
- d) *Length of variable part* – A 2 octet field giving the length in octets of the variable part (inquiry or reply) coded as an unsigned integer. As an example, 2612 would be coded as hex '0A34'.

The variable part holds the DA message (inquiry or reply) as defined by clause 10 or 11. The DA message may be encrypted.

12.5 Application connection release

There is no explicit release of the application connection. An application is released when the supporting TCP connection is released (see 13.3).

13 Use of the service provided by the TCP protocol

The use of the service provided by TCP is expressed by reference to the conceptual calls as defined in 3.8 of RFC 793.

NOTE – An application programming interface implementation may have different structure.

13.1 TCP connection establishment (socket connection)

Only the inquiring system may initiate a TCP connection. Such a connection has to be established before the inquiring system can send inquiries. A connection is established by the inquiring system issuing an active OPEN call and by the relying system having an outstanding passive OPEN call (see 3.4 of RFC 793).

When issuing an active OPEN, the inquiring system shall:

- a) Specify the socket of the replying system as published by the replying system. It is recommended to use the port number *3611* for replying systems. However, for more flexibility and to avoid potential port assignment problems, the inquiring system shall be able to configure the port number of the replying system.
- b) Set the active flag.

NOTE – Because many operating systems do not support fixed outgoing TCP port, only dynamic allocation of port number is used.

An active OPEN will fail if the replying system has not issued a passive OPEN.

If duplicated equipment exists, the inquiring application may set up an active TCP Connection to this equipment, even if it already has an active TCP Connection to this DA system.

When issuing a passive OPEN, the replying system shall:

- a) Specify the local port number to be used (3611 is recommended).

13.2 Data transfer

When an inquiring or replying system issues a SEND call to send an inquiry or reply, respectively:

- the PUSH flag shall be set to ensure immediate delivery; and
- the URGENT flag shall not be set.

If the number of octets received in a TCP stream is less than 12, the receiving system shall wait for next stream of octets until 12 octets are received and it is possible to determine the variable length.

13.3 TCP connection release

The connection can be released by either:

- closing the connection, which leads to terminating gracefully the message flow; or
- aborting the connection, which leads to delete the ongoing messages.

For performance reasons, connections should be maintained and not be released after each transaction.

13.3.1 Orderly release

Either side may issue a CLOSE at any time.

An inquiring system should normally not issue a CLOSE when it has outstanding inquiries.

An inquiring system should have an inactivity time-out period on, say, 15 minutes, after which it may issue a CLOSE.

A replying system should issue a CLOSE on such a connection at regular intervals to allow the authentication procedure to be repeated.

NOTE – As an example, a replying system might issue a CLOSE on a connection after having processed 1000 transactions on that connection

A replying system should also have a prolonged inactivity timer to protect against the failure of the inquiring system to close the connection after a period of inactivity. After the expiration of such an inactivity timer, the replying system should issue a CLOSE.

When an inquiring system receives a CLOSE indication when it has outstanding inquiries on the connection in question, it should take local action with respect to the missing replies, e.g. by opening a new connection and re-transmitting the lost inquiries.

13.3.2 TCP ABORT

A system should only issue an ABORT whenever it detects a serious exception, such as an abnormal functioning communication partner or unsuccessful authentication.

14 Operator Manual

Each service provider that implements this Recommendation shall supply a simple Operator Manual for foreign service providers. This manual describes principally the main characteristics of its directory assistance system to indicate the best way to inquire for the remote operators.

Annex A

Directory Assistance keywords of Directory Assistance protocol version 1

(This annex forms an integral part of this Recommendation)

A.1 Functional keywords Table

Bilateral agreement is needed for all Functional Keywords.

Keyword	Authorised fields		Description	Syntax of the <data> field
	Field 1	Field 2		
Users generated				
#ADR	X	X	<p>The presence of the keyword “#ADR” indicates that a subscriber search by street address shall be performed under the following conditions:</p> <ul style="list-style-type: none"> • The geographical area shall be unambiguous, if not, a locality list is provided (general E115v1 rule) • The street name is mandatory • All other search arguments shall be used as filters <p>If the combination of locality – Street Name specified in the query is not defined in the system the message code "64" shall be returned</p> <p>Syntax <u>In the request, (field 1):</u> To retrieve a list of subscribers recorded under a given Street Name. <u>In the reply, (field 2):</u> To indicate that this functionality has actually been effected.</p>	No data
#ALT	X	X	<p>The presence of the keyword “#ALT” activates alternative matching rules. If no keyword is used, the alternative matching rule shall not be activated</p> <p>Note #ALT=0 is the value for phonetic search #ALT=1 is the value for word rotation #ALT=2 is the value for position sensitive search #ALT is kept as an alternative to #ALT=0</p> <p>Syntax <u>In the request, (field 1):</u> To search for subscribers with an alternative matching rule. <u>In the reply, (field 2):</u> To indicate that this functionality has actually been effected.</p>	<p>=<number>-defines type of alternative matching rule</p> <p>Set to value 0 or greater.</p> <p>Value 0 is left to the discretion of the service provider to provide the best choice.</p> <p>The type of alternative matching rule should be defined by the service provider in the User Manual.</p> <p>Default value is 0.</p>

#BUS	X	X	<p>List of business categories when the business category in the request is ambiguous.</p> <p>The business category can be supplied with complete or truncated words in the request.</p> <p>The language to be used for the business category will depend on bilateral agreement.</p> <p>If <u>both</u> the locality <u>and</u> the business category provided in the request are ambiguous, a locality list is provided first. A list of business categories will be returned after a valid locality has been selected.</p> <p>When a list of business categories is provided, the reply message shall be formatted according to the following :</p> <p><u>1. Information to be returned</u></p> <ul style="list-style-type: none">- Use of the <i>heading in the guide</i> field to return the information for business category.- Optional use of the <i>Supplementary Data</i> field to return potential additional information such as a more general business area description field to which the business category returned belongs. (for information and display only) <p><u>2. Return code to be used</u></p> <p>The return code to be used is 76 "List of business categories".</p> <p>Note</p> <p>When a business category list is actually returned, it shall be done in such a way that the content of the <i>Heading in the Guide</i> field from the reply can be used in a subsequent request without having to be modified by the requesting system. To achieve unambiguity in provision of the list, the number sign character can be used according to E.115 specifications.</p> <p>Data provided in the <i>supplementary data</i> field is informational only, and should not have to be sent in a subsequent request together with the <i>Heading in the guide</i> field retrieved from the list.</p> <p>Syntax</p> <p><u>In the request, (field 1):</u> Should be provided to enable the return of a business category list</p> <p><u>In the reply, (field 2):</u> Shall be provided if this functionality has been activated by the service provider.</p> <p>If the keyword is transmitted by the requestor, the service provider may return:</p> <ul style="list-style-type: none">- a list of subscribers if the provided business category isn't ambiguous,- a list of business categories if the provided category is ambiguous,- an error code if no match can be found with the provided category. <p>If the keyword is <i>not</i> transmitted in the request, the service provider <i>never</i> returns a list of business categories (Same behaviour as if no agreement has been reached)</p>	No data
------	---	---	--	---------

#GEO	X	X	<p>Search for subscriber by geographical expansion.</p> <p>Syntax <u>In the request, (field 1):</u> To expand the subscriber search to neighbouring areas. <u>In the reply, (field 2):</u> To indicate that this functionality has actually been effected.</p>	<p>=<number></p> <p>Set to value 0 or greater which specifies the degree of expansion as determined by the service provider (the actual mapping should be described in the User Guide).</p> <p>Default value is 0.</p> <p>Example (purely fictional): #GEO=0 search for subscribers expanded to include direct neighbouring localities #GEO=1 search for subscribers expanded to the county associated to the entered locality</p>
#MAI	X	X	<p>The presence of the keyword “#MAI” indicates a search for Level 0 entries only in databases having grouped listings. The top line of a grouped listing has the level equal to 0 (zero).</p> <p>Syntax <u>In the request, (field 1)</u> To search for subscribers where only the top line (level zero) of a grouped listing is returned. <u>In the reply, (field 2):</u> To indicate that this functionality has actually been effected.</p>	<p>No data</p>
#NAT	X	X	<p>This concerns the introduction of characters that are not part of the basic E.115 character set, but are used in some countries.</p> <p>Note #NAT=ab where a is the character set for the inquiry and b the character set required in the reply, a and b could be equal to 0 or 1, 0 is the value for basic E.115 (minimum character set) and 1 is the value for ISO Latin1 (8859-1) EIDQ extended character set.</p> <p>Syntax <u>In the request, (field 1):</u> To specify the character set of the inquiry (a) and the character set required in the reply (b). <u>In the reply, (field 2):</u> To specify the character set of the inquiry (a) and the character set required in the reply (b).</p>	<p>ab</p> <p>a =</p> <p>0 : basic E115 character set 1 : ISO-8859-1 character set</p> <p>b =</p> <p>0 : basic E115 character set 1 : ISO-8859-1 character set</p> <p>Default value is #NAT=00</p>

#NEI	X	X	<p>The presence of the keyword “#NEI” indicates a search for neighbouring localities.</p> <p>Syntax <u>In the request, (field 1):</u> To search for localities included in the geographical area defined by the data field. <u>In the reply, (field 2):</u> to indicate that this functionality has actually been effected.</p>	<p>=<number></p> <p>Set to value 0 or greater which specifies the geographical area on which the search shall be performed (the actual mapping is determined by the service provider and should be described in the User Guide).</p> <p>Default value is 0.</p> <p>Example (purely fictional): #NEI=0 search for localities expanded to include direct neighbouring localities. #NEI=1 search for localities containing the localities of the associated county.</p>
#PRO	X	X	<p>The presence of the keyword “#PRO” indicates a search for subscribers by profession.</p> <p>Syntax <u>In the request, (field 1):</u> To retrieve a list of subscribers recorded under a given profession. <u>In the reply, (field 2):</u> To indicate that this functionality has actually been effected.</p>	<p>No data</p>
#PRX	X	X	<p>Proximity search. Proximity searches are introduced within E.115 in order to enable Directory Assistance operators to search for subscribers (business listings) next to an end-user defined position in order to retrieve listings ordered by either increasing distance or including geo-coordinates.</p> <p>Syntax <u>In the request, (field 1):</u> Should be provided to enable the functionality in case of indication of a radius. <u>In the reply, (field 2):</u> Shall be provided if this functionality has been activated by the service provider.</p>	<p>=<number></p> <p>Set to « no-value » or « number » which specifies the search distance (radius) as determined by the service provider (the actual mapping should be described in the User Guide).</p> <p>=<number> is corresponding to the distance between the centre of the search and the corresponding listing in reply.</p>

#REV	X	X	<p>Reverse search. In a reversed search, the number is the search argument. It shall be placed in the field “subscriber name”</p> <p>NOTE – In combination with the keyword “PRX”, this keyword defines the end-user position by provision of a phone number. In this case #REV=<number> can be used.</p> <p>Syntax:</p> <p><u>In the request, (field 1):</u> To specify a reverse search.</p> <p><u>In the reply, (field 2):</u> To indicate that this functionality has actually been effected.</p>	<p>No data</p> <p>Or:</p> <p>For Proximity Search:</p> <p>=<number></p> <p>contains the telephone number that is used as the centre point of the proximity search.</p>
#POS	X	X	<p>Asking and/or Transmitting location (X,Y coordinates) of the source/origin point of the search.</p> <p>Syntax:</p> <p><u>In the request, (field 1):</u> Coordinates of the source/origin point for a proximity search</p> <p><u>In the reply, (field 2):</u> Will be used if the functionality has been activated.</p>	<p>empty or</p> <p>=<x_coordinate>,<y_coordinate></p> <p>Might be completed with positioning data.</p>
#DES		X	<p>Providing location (through X,Y coordinates) of the retrieved subscribers</p> <p>Syntax:</p> <p><u>In the reply, (field 2):</u> Shall be provided with the X,Y coordinates of the retrieved subscriber defined position.</p>	<p>=<coordinates_string>=<string2></p> <p>where coordinates_string represents each retrieved listings localisation.</p>
#MLS	X	X	<p>Multi-locality search. If the MLS (Multi-Locality-Search) is implemented in the database the search with your name and address will be taken in all the localities that achieve all the assumptions the operator has written in the locality field.</p> <p>Syntax:</p> <p><u>In the request, (field 1):</u> To search for subscribers where only listings which are in a locality with the requested locality name.</p> <p><u>In the reply, (field 2):</u> To indicate that this functionality has actually been effected.</p> <p>If no keyword is used, the type(s) of communication address provided is left to the discretion of the service provider and should be described in the User Manual.</p>	<p>No data</p>

#MSS	X	X	<p>This keyword allows on a search basis to turn off the list of street address functionality and to search on the whole list street addresses retrieved by the search. Thus, it only has an effect if the list of street address functionality has been bilaterally agreed.</p> <p>If the MSS (Multi-Street-Search) is implemented in the database, the search will be performed in all the street addresses which achieve all the assumptions the operator has written in the street field.</p> <p>To activate the MSS you have to write the keyword “#MSS” in the AISS field after receiving a list of street addresses.</p> <p>If the service provider has the restriction in the number of street addresses, the system will return an error code “64” which means “too many street names found”.</p> <p>If there are too many listings in the reply there will be come back the error code “93” which means “too many selections found”.</p> <p>Syntax:</p> <p><u>In the request, (field 1):</u> Should be provided to enable the return of a search on the whole list.</p> <p><u>In the reply, (field 2):</u> Shall be provided if this functionality has been activated by the service provider.</p>	No data
#EML		X	<p>This Keyword allows to provide the Email address (and/or URL) within the listing.</p> <p>NOTE – The implementation of this Keyword implies that the character set is extended (to support the “@” character for instance) as well as the field lengths (to adapt to Email and URL addresses lengths). When using the limited character set, notation within RFC 2156 shall be used – '@' represented as '(a)'.</p> <p>Syntax;</p> <p><u>In the reply, (field 2):</u> To return the email address of the corresponding subscriber.</p>	<p>=<string></p> <p>The <string> contains the email address of the corresponding subscriber</p>
#URL		X	<p>This Keyword allows providing the URL (and/or Email) within the listing.</p> <p>Syntax:</p> <p><u>In the reply, (field 2):</u> To return the URL of the corresponding subscriber</p>	<p>=<string></p> <p>The <string> contains the URL of the corresponding subscriber</p>

<p>#FAX #GSM #FTN #TEL #ISD #PBX #TXT</p>	<p>X</p>	<p>X</p>	<p>These keywords offer the end user (operator or public) the possibility to search for subscribers with selection of listings regarding a specific type of communication address.</p> <p>They shall be used in accordance with the following syntax and be used only in an “AND”-relationship:</p> <p>Syntax:</p> <p><u>In the request, (field 1):</u> To search for subscribers where only listings with the type of communication address corresponding to the keyword(s) specified are returned:</p> <p style="padding-left: 40px;">#FAX (search for Fax)</p> <p style="padding-left: 40px;">#GSM (search for mobile telephone numbers)</p> <p style="padding-left: 40px;">#FTN (search for Free Tax Number)</p> <p style="padding-left: 40px;">#TEL (search for Telephone Number)</p> <p style="padding-left: 40px;">#ISD (search for ISDNs)</p> <p style="padding-left: 40px;">#PBX (search for switch board Number)</p> <p style="padding-left: 40px;">#TXT (search for text-telephone Number)</p> <p>e.g.:</p> <p>#FAX means that only fax numbers shall be provided.</p> <p>#FAX and #FTN means that free tax fax numbers shall be provided.</p> <p><u>In the reply, (field 2):</u> To indicate that this functionality has actually been effected.</p> <p>If no keyword is used, the type(s) of communication address provided is left to the discretion of the service provider and should be described in the User Manual.</p> <p>Note These Keywords are already approved as descriptive keywords (see A.2).</p>	<p>No data</p>
System generated				
<p>#LEV</p>		<p>X</p>	<p>The keyword “#LEV” shall be used in accordance with the following definition:</p> <p>Each line from grouped entries is considered as a single listing. To identify its position within the group, a level identifier is created. The top line has the level equal to 0. The level identifier is incremented for each new sub-grouping (see example below).</p> <p style="padding-left: 40px;">NOTE – This keyword is optional, if not used, the level of listing is equal 0.</p> <p>Syntax:</p> <p><u>In the reply, (field 2):</u> to specify the level of a listing within a grouped entry (caption set)</p>	<p>=<number></p> <p>Level identifier: number identifying the level of listing within grouped entries. The top level is equal to 0</p>

#CCO		X	<p>The keyword “#CCO” allows that a single E.115 reply contains subscribers belonging to different countries.</p> <p>Note This keyword is optional, if not used, the “country code” field of part 2 is valid</p> <p>Syntax: <u>In the reply, (field 2):</u> To return the telephone country code of the corresponding subscriber</p> <p>This country code override the code returned in the “country code” field of part 2</p>	<p>=<string></p> <p>The <string> contains the country code of the corresponding subscriber. In accordance with the ITU-T recommendations E163</p> <p>e.g. : 357</p> <p>means in relationship with France : Override the country code 33 in part 2 with 357 (Monaco)</p>
------	--	---	--	---

field1 “Additional information for a selective search” field (inquiry)

field2 “Additional information for a selective search” field (reply)

A.2 Descriptive keywords Table

Keyword	Reply: Supplementary Data*	Type of communication address
EML	X	E-mail addresses
FAX	X	Fax number
FTN	X	Free tax number
GSM	X	Mobile telephone number
ISD	X	ISDN number
NPN	X	Personal country wide number
OLD	X	Old telephone number
PAG	X	Pager number
PBX	X	Switchboard number
PRN	X	Premium rate number
PUB	X	Public phone-box number
TXT	X	Text-telephone number
UPN	X	Personal world wide number
URL	X	Internet addresses
VID	X	Video-telephone number.

In the reply, the descriptive keyword shall be only returned if the information is available in the accessed Database.

Annex B

Directory Assistance protocol version 1 in ASN.1

(This annex forms an integral part of this Recommendation)

```
E115v1 {itu-t recommendation(0) e(5) 115 1} DEFINITIONS ::=
BEGIN

E115String ::= IA5String

E115StringUb256 ::= E115String (SIZE(1..256))

DirectoryMessage ::= CHOICE {
    telephone [0] Telephone }

Telephone ::= CHOICE {
    inquiry [0] Inquiry,
    reply [1] Reply }

Inquiry ::= SEQUENCE {
    inquiryPart1 InquiryPart1,
    inquiryPart2 InquiryPart2 }

InquiryPart1 ::= [ APPLICATION 0 ] IMPLICIT SET {
    messageIndicators [0] IMPLICIT E115String (SIZE(4)),
    internationalIndicator [1] IMPLICIT NumericString (SIZE(8)),
    originatingTerminalCode [2] IMPLICIT E115String (SIZE(8)),
    dateAndTime [3] IMPLICIT NumericString (SIZE(12)) OPTIONAL,
    messageNumber [4] IMPLICIT E115String (SIZE(4)) OPTIONAL }

InquiryPart2 ::= [ APPLICATION 1 ] IMPLICIT SET {
    locality [0] IMPLICIT E115StringUb256 OPTIONAL,
    subscriberName [1] IMPLICIT E115StringUb256 OPTIONAL,
    streetName [2] IMPLICIT E115StringUb256 OPTIONAL,
    houseNumber [3] IMPLICIT E115StringUb256 OPTIONAL,
    forename [4] IMPLICIT E115StringUb256 OPTIONAL,
    headingInTheGuide [5] IMPLICIT E115StringUb256 OPTIONAL,
    professionCode [6] IMPLICIT E115StringUb256 OPTIONAL,
    additionalInformationForASelectiveSearch [7] IMPLICIT E115StringUb256 OPTIONAL,
    countyStateOrProvince [8] IMPLICIT E115StringUb256 OPTIONAL,
    category [9] IMPLICIT E115StringUb256 OPTIONAL,
    sequenceNumber [10] IMPLICIT NumericString (SIZE(1)) OPTIONAL }

Reply ::= SEQUENCE {
    replyPart1 ReplyPart1,
    replyPart2 ReplyPart2,
    replyPart3 ReplyPart3 OPTIONAL }

ReplyPart1 ::= [ APPLICATION 3 ] IMPLICIT SET {
    messageIndicators [0] IMPLICIT E115String (SIZE(4)),
    internationalIndicators [1] IMPLICIT NumericString (SIZE(8)),
    originatingTerminalCode [2] IMPLICIT E115String (SIZE(8)),
    dateAndTime [3] IMPLICIT NumericString (SIZE(12)) OPTIONAL,
    messageNumber [4] IMPLICIT E115String (SIZE(4)) OPTIONAL }

ReplyPart2 ::= [ APPLICATION 4 ] IMPLICIT SET {
    messageCode [0] IMPLICIT E115String (SIZE(2)),
    countryCode [1] IMPLICIT E115String (SIZE(4)),
    message [2] IMPLICIT E115StringUb256 OPTIONAL,
```

dbSelectionCount [3] IMPLICIT E115String (SIZE(1..10)) OPTIONAL }

ReplyPart3 ::= [APPLICATION 5] IMPLICIT SET OF Selection

```
Selection ::= SET {
  nationalDestinationCode [0] IMPLICIT E115StringUb256 OPTIONAL,
  subscriberNumber [1] IMPLICIT E115StringUb256 OPTIONAL,
  locality [2] IMPLICIT E115StringUb256 OPTIONAL,
  subscriberName [3] IMPLICIT E115StringUb256 OPTIONAL,
  forename [4] IMPLICIT E115StringUb256 OPTIONAL,
  streetName [5] IMPLICIT E115StringUb256 OPTIONAL,
  houseNumber [6] IMPLICIT E115StringUb256 OPTIONAL,
  supplementaryData [7] IMPLICIT E115StringUb256 OPTIONAL,
  subscriberMessage [8] IMPLICIT E115StringUb256 OPTIONAL,
  headingInTheGuide [9] IMPLICIT E115StringUb256 OPTIONAL,
  professionCode [10] IMPLICIT E115StringUb256 OPTIONAL,
  additionalInformationForASelectiveSearch
  [11] IMPLICIT E115StringUb256 OPTIONAL,
  countyStateOrProvince [12] IMPLICIT E115StringUb256 OPTIONAL,
  category [13] IMPLICIT E115StringUb256 OPTIONAL,
  subscriberDescription [14] IMPLICIT E115StringUb256 OPTIONAL }
```

END

Annex C

Directory Assistance protocol version 2 in ASN.1

(This annex forms an integral part of this Recommendation)

This annex provides the ASN.1 specification for version 2 of the protocol. If the ASN.1 EXTENDED-XER encoding rules are used, the XML encoding produced is identical to an XML encoding based on the XSD specified in Annex D.

```
E115v2 {itu-t recommendation(0) e(5) 115 2} DEFINITIONS XER INSTRUCTIONS ::=
BEGIN

E115String ::= UTF8String (FROM (
    {0, 0, 0, 32}..{0, 0, 0, 122} |
    {0, 0, 0, 160}..{0, 0, 215, 255} |
    {0, 0, 224, 0}..{0, 0, 255, 253}))

E115StringUb256 ::= E115String (SIZE(1..256))

E115NumericString ::= [NAME AS "NumericString"]
    UTF8String (FROM ( {0, 0, 0, 48}..{0, 0, 0, 57} ))

SimpleAttribute ::= BOOLEAN (CONSTRAINED BY
    { /* Shall only take the value TRUE */ } )

CharacterSetType ::= ENUMERATED {
    basic (0),
    latin1 (1) }

GeographicalType ::= ENUMERATED {
    dms (0),
    dec (1) }

E115Message ::= CHOICE {
    directoryMessage [TAG: 0] DirectoryMessage }

DirectoryMessage ::= CHOICE {
    inquiry [TAG: 0] Inquiry,
    reply [TAG: 1] Reply }

Inquiry ::= SEQUENCE {
    inquiryHeader InquiryHeader,
    inquiryData InquiryData }

InquiryHeader ::= [ TAG: APPLICATION 0 ] IMPLICIT SET {
    -- [TAG: 0] This tag is obsolete for v2 - not to be reused
    -- [TAG: 1] This tag is obsolete for v2 - not to be reused
    originatingTerminalCode [ATTRIBUTE][TAG: 2] IMPLICIT E115String (SIZE(8)),
    dateAndTime [ATTRIBUTE][TAG: 3] IMPLICIT E115NumericString (SIZE(12))
        OPTIONAL,
    messageNumber [ATTRIBUTE][TAG: 4] IMPLICIT E115String (SIZE(4)) OPTIONAL,
    countryName [ATTRIBUTE][TAG: 5] IMPLICIT E115String (SIZE(2)),
    providerCode [ATTRIBUTE][TAG: 6] IMPLICIT E115String (SIZE(3)) OPTIONAL,
    inquiryCharacterSet [ATTRIBUTE][TAG: 7] IMPLICIT CharacterSetType DEFAULT basic,
    replyCharacterSet [ATTRIBUTE][TAG: 8] IMPLICIT CharacterSetType DEFAULT
latin1,
    requestedReplyType [ATTRIBUTE][TAG: 9] IMPLICIT ENUMERATED {
        subscriberList (0),
        provinceList (1),
        localityList (2),
        streetList (3),
        businessCategoryList (4)} DEFAULT subscriberList,
    acceptedReplyTypes [TAG: 10] IMPLICIT SEQUENCE {
        provinceList [ATTRIBUTE][TAG: 0] IMPLICIT SimpleAttribute OPTIONAL,
        localityList [ATTRIBUTE][TAG: 1] IMPLICIT SimpleAttribute OPTIONAL,
        streetList [ATTRIBUTE][TAG: 2] IMPLICIT SimpleAttribute OPTIONAL,
```

```
businessCategoryList      [ATTRIBUTE][TAG: 3]  IMPLICIT SimpleAttribute OPTIONAL } }

InquiryData ::= [ TAG: APPLICATION 1 ] IMPLICIT SET {
  locality                 [TAG: 0]  IMPLICIT E115StringUb256 OPTIONAL,
  subscriberName          [TAG: 1]  IMPLICIT E115StringUb256 OPTIONAL,
  streetName              [TAG: 2]  IMPLICIT E115StringUb256 OPTIONAL,
  houseNumber             [TAG: 3]  IMPLICIT E115StringUb256 OPTIONAL,
  forename                [TAG: 4]  IMPLICIT E115StringUb256 OPTIONAL,
  headingInTheGuide      [TAG: 5]  IMPLICIT E115StringUb256 OPTIONAL,
  professionCode         [TAG: 6]  IMPLICIT E115StringUb256 OPTIONAL,
  --                      [TAG: 7]  This tag is obsolete for v2 - not to be reused
  countyStateOrProvince [TAG: 8]  IMPLICIT E115StringUb256 OPTIONAL,
  --                      [TAG: 9]  This tag is obsolete for v2 - not to be reused
  category                [TAG: 10] IMPLICIT SEQUENCE {
    business              [ATTRIBUTE][TAG: 0] IMPLICIT SimpleAttribute OPTIONAL,
    residential          [ATTRIBUTE][TAG: 1] IMPLICIT SimpleAttribute OPTIONAL,
    government            [ATTRIBUTE][TAG: 2] IMPLICIT SimpleAttribute OPTIONAL }
    OPTIONAL,
  sequenceNumber         [ATTRIBUTE][TAG: 11] IMPLICIT
                        E115NumericString (SIZE(1..2)) DEFAULT "0",
  postalCode             [TAG: 12] IMPLICIT E115StringUb256 OPTIONAL,
  nationalDestinationCode [TAG: 13] IMPLICIT E115NumericString(SIZE(1..14)) OPTIONAL,
  commAddress           [TAG: 14] IMPLICIT E115StringUb256 OPTIONAL,
  commAddressTypes      [TAG: 15] IMPLICIT SEQUENCE {
    e164                 [ATTRIBUTE][TAG: 0] IMPLICIT SimpleAttribute OPTIONAL,
    rfc822               [ATTRIBUTE][TAG: 1] IMPLICIT SimpleAttribute OPTIONAL,
    rfc1738              [ATTRIBUTE][TAG: 2] IMPLICIT SimpleAttribute OPTIONAL }
    OPTIONAL,
  additionalName        [TAG: 16] IMPLICIT E115StringUb256 OPTIONAL,
  commAddressService    [TAG: 17] IMPLICIT SEQUENCE {
    fax                  [ATTRIBUTE][TAG: 0] IMPLICIT SimpleAttribute OPTIONAL,
    pbx                  [ATTRIBUTE][TAG: 1] IMPLICIT SimpleAttribute OPTIONAL,
    txt                  [ATTRIBUTE][TAG: 2] IMPLICIT SimpleAttribute OPTIONAL,
    pub                  [ATTRIBUTE][TAG: 3] IMPLICIT SimpleAttribute OPTIONAL,
    vid                  [ATTRIBUTE][TAG: 4] IMPLICIT SimpleAttribute OPTIONAL,
    pag                  [ATTRIBUTE][TAG: 5] IMPLICIT SimpleAttribute OPTIONAL,
    voice                [ATTRIBUTE][TAG: 6] IMPLICIT SimpleAttribute OPTIONAL,
    data                 [ATTRIBUTE][TAG: 7] IMPLICIT SimpleAttribute OPTIONAL,
    http                 [ATTRIBUTE][TAG: 8] IMPLICIT SimpleAttribute OPTIONAL,
    ftp                  [ATTRIBUTE][TAG: 9] IMPLICIT SimpleAttribute OPTIONAL,
    eml                  [ATTRIBUTE][TAG: 10] IMPLICIT SimpleAttribute OPTIONAL,
    sms                  [ATTRIBUTE][TAG: 11] IMPLICIT SimpleAttribute OPTIONAL,
    mms                  [ATTRIBUTE][TAG: 12] IMPLICIT SimpleAttribute OPTIONAL,
    emg                  [ATTRIBUTE][TAG: 13] IMPLICIT SimpleAttribute OPTIONAL }
    OPTIONAL,
  commAddressChar       [TAG: 18] IMPLICIT SEQUENCE {
    ftn                  [ATTRIBUTE][TAG: 0] IMPLICIT SimpleAttribute OPTIONAL,
    mob                  [ATTRIBUTE][TAG: 1] IMPLICIT SimpleAttribute OPTIONAL,
    fixed                [ATTRIBUTE][TAG: 2] IMPLICIT SimpleAttribute OPTIONAL }
    OPTIONAL,
  geoExpansion          [ATTRIBUTE][TAG: 19] IMPLICIT
                        E115NumericString (SIZE(1..3)) OPTIONAL,
  searchCoordinate      [TAG: 20] IMPLICIT SEQUENCE {
    searchRadius         [ATTRIBUTE] [TAG: 0] IMPLICIT NumericString (SIZE(1..9))
                        OPTIONAL,
    latitude             [TAG: 1] IMPLICIT E115String,
    longitude            [TAG: 2] IMPLICIT E115String,
    geodeticDatum        [ATTRIBUTE] [TAG: 3] IMPLICIT E115String OPTIONAL,
    projection           [ATTRIBUTE] [TAG: 4] IMPLICIT E115String OPTIONAL,
    geographical         [ATTRIBUTE] [TAG: 5] IMPLICIT GeographicalType DEFAULT dec
  }
  OPTIONAL,
  matchingRule          [TAG: 21] IMPLICIT SEQUENCE {
    wordRotation         [ATTRIBUTE][TAG: 0] IMPLICIT BOOLEAN OPTIONAL,
    phonetic             [ATTRIBUTE][TAG: 1] IMPLICIT BOOLEAN OPTIONAL,
    alias                [ATTRIBUTE][TAG: 2] IMPLICIT BOOLEAN OPTIONAL } OPTIONAL,
  maxSelectionLevel     [ATTRIBUTE][TAG: 22] IMPLICIT
                        E115NumericString (SIZE(1..3)) DEFAULT "99" }
```

```
Reply ::= SEQUENCE {
    replyHeader ReplyHeader,
    selections SEQUENCE (SIZE(1..MAX)) OF Selection OPTIONAL }

ReplyHeader ::= [TAG: APPLICATION 3] IMPLICIT SET {
    -- [TAG: 0] This tag is obsolete for v2 - not to be reused
    -- [TAG: 1] This tag is obsolete for v2 - not to be reused
    originatingTerminalCode [ATTRIBUTE][TAG: 2] IMPLICIT E115String (SIZE(8)),
    dateAndTime [ATTRIBUTE][TAG: 3] IMPLICIT E115NumericString (SIZE(12))
        OPTIONAL,
    messageNumber [ATTRIBUTE][TAG: 4] IMPLICIT E115String (SIZE(4)) OPTIONAL,
    messageCode [ATTRIBUTE][TAG: 5] IMPLICIT E115String (SIZE(2)),
    message [TAG: 6] IMPLICIT E115StringUb256 OPTIONAL,
    dbSelectionCount [ATTRIBUTE][TAG: 7] IMPLICIT E115String (SIZE(1..10))
        OPTIONAL,
    replyCharacterSet [ATTRIBUTE][TAG: 8] IMPLICIT CharacterSetType OPTIONAL }

Selection ::= SET {
    nationalDestinationCode [TAG: 0] IMPLICIT E115NumericString (SIZE(1..14)) OPTIONAL,
    commAddress [TAG: 1] IMPLICIT E115StringUb256 OPTIONAL,
    locality [TAG: 2] IMPLICIT E115StringUb256 OPTIONAL,
    subscriberName [TAG: 3] IMPLICIT E115StringUb256 OPTIONAL,
    forename [TAG: 4] IMPLICIT E115StringUb256 OPTIONAL,
    streetName [TAG: 5] IMPLICIT E115StringUb256 OPTIONAL,
    houseNumber [TAG: 6] IMPLICIT E115StringUb256 OPTIONAL,
    supplementaryData [TAG: 7] IMPLICIT E115StringUb256 OPTIONAL,
    subscriberMessage [TAG: 8] IMPLICIT E115StringUb256 OPTIONAL,
    headingInTheGuide [TAG: 9] IMPLICIT E115StringUb256 OPTIONAL,
    professionCode [TAG: 10] IMPLICIT E115StringUb256 OPTIONAL,
    -- [TAG: 11] This tag is obsolete for v2 - not to be reused
    countyStateOrProvince [TAG: 12] IMPLICIT E115StringUb256 OPTIONAL,
    -- [TAG: 13] This tag is obsolete for v2 - not to be reused
    subscriberDescription [TAG: 14] IMPLICIT E115StringUb256 OPTIONAL,
    category [TAG: 15] IMPLICIT SEQUENCE {
        business [ATTRIBUTE][TAG: 0] IMPLICIT SimpleAttribute OPTIONAL,
        residential [ATTRIBUTE][TAG: 1] IMPLICIT SimpleAttribute OPTIONAL,
        government [ATTRIBUTE][TAG: 2] IMPLICIT SimpleAttribute OPTIONAL }
        OPTIONAL,
    countryCode [TAG: 16] IMPLICIT E115NumericString (SIZE(1..3)),
    postalCode [TAG: 17] IMPLICIT E115StringUb256 OPTIONAL,
    commAddressType [ATTRIBUTE][TAG: 18] IMPLICIT ENUMERATED {
        e164 (0),
        rfc822 (1),
        rfc1738 (2) } OPTIONAL,
    commAddressService [TAG: 19] IMPLICIT SEQUENCE {
        fax [ATTRIBUTE][TAG: 0] IMPLICIT SimpleAttribute OPTIONAL,
        pbx [ATTRIBUTE][TAG: 1] IMPLICIT SimpleAttribute OPTIONAL,
        txt [ATTRIBUTE][TAG: 2] IMPLICIT SimpleAttribute OPTIONAL,
        pub [ATTRIBUTE][TAG: 3] IMPLICIT SimpleAttribute OPTIONAL,
        vid [ATTRIBUTE][TAG: 4] IMPLICIT SimpleAttribute OPTIONAL,
        pag [ATTRIBUTE][TAG: 5] IMPLICIT SimpleAttribute OPTIONAL,
        voice [ATTRIBUTE][TAG: 6] IMPLICIT SimpleAttribute OPTIONAL,
        data [ATTRIBUTE][TAG: 7] IMPLICIT SimpleAttribute OPTIONAL,
        http [ATTRIBUTE][TAG: 8] IMPLICIT SimpleAttribute OPTIONAL,
        ftp [ATTRIBUTE][TAG: 9] IMPLICIT SimpleAttribute OPTIONAL,
        eml [ATTRIBUTE][TAG: 10] IMPLICIT SimpleAttribute OPTIONAL,
        sms [ATTRIBUTE][TAG: 11] IMPLICIT SimpleAttribute OPTIONAL,
        mms [ATTRIBUTE][TAG: 12] IMPLICIT SimpleAttribute OPTIONAL,
        emg [ATTRIBUTE][TAG: 13] IMPLICIT SimpleAttribute OPTIONAL }
        OPTIONAL,
    commAddressChar [TAG: 20] IMPLICIT SEQUENCE {
        ftn [ATTRIBUTE][TAG: 0] IMPLICIT SimpleAttribute OPTIONAL,
        mob [ATTRIBUTE][TAG: 1] IMPLICIT SimpleAttribute OPTIONAL,
        fixed [ATTRIBUTE][TAG: 2] IMPLICIT SimpleAttribute OPTIONAL,
        prn [ATTRIBUTE][TAG: 3] IMPLICIT SimpleAttribute OPTIONAL,
        npn [ATTRIBUTE][TAG: 4] IMPLICIT SimpleAttribute OPTIONAL,
        upn [ATTRIBUTE][TAG: 5] IMPLICIT SimpleAttribute OPTIONAL,
```

```
old [ATTRIBUTE][TAG: 6] IMPLICIT SimpleAttribute OPTIONAL,  
adv [ATTRIBUTE][TAG: 7] IMPLICIT SimpleAttribute OPTIONAL,  
nmk [ATTRIBUTE][TAG: 8] IMPLICIT SimpleAttribute OPTIONAL }  
    OPTIONAL,  
distance [TAG: 21] IMPLICIT E115StringUb256 OPTIONAL,  
searchCenter [TAG: 22] IMPLICIT E115StringUb256 OPTIONAL,  
additionalName [TAG: 23] IMPLICIT E115StringUb256 OPTIONAL,  
selectionCoordinate [TAG: 24] IMPLICIT SEQUENCE {  
    latitude [TAG: 1] E115String,  
    longitude [TAG: 2] E115String,  
    geodeticDatum [ATTRIBUTE] [TAG: 3] IMPLICIT E115String OPTIONAL,  
    projection [ATTRIBUTE] [TAG: 4] IMPLICIT E115String OPTIONAL,  
    geographical [ATTRIBUTE] [TAG: 5] IMPLICIT GeographicalType DEFAULT dec  
}  
    OPTIONAL,  
selectionLevel [ATTRIBUTE][TAG: 25]  
    IMPLICIT E115NumericString (SIZE(1..3)) DEFAULT "0" }
```

```
ENCODING-CONTROL XER  
    GLOBAL-DEFAULTS MODIFIED-ENCODINGS
```

END

Annex D

Directory assistance protocol version 2 in XSD

(This annex forms an integral part of this Recommendation)

```
<?xml version="1.0" encoding="UTF-8"?>

<xsd:schema xmlns:xsd="http://www.w3.org/2001/XMLSchema">
  <xsd:simpleType name="E115String">
    <xsd:restriction base="xsd:string">
      <xsd:pattern value="[\&#x20;-&#x7A;&#xA0;-&#xD7FF;&#xE000;-&#xFFFD;]*"/>
    </xsd:restriction>
  </xsd:simpleType>
  <xsd:simpleType name="E115StringUb256">
    <xsd:restriction base="E115String">
      <xsd:minLength value="1"/>
      <xsd:maxLength value="256"/>
    </xsd:restriction>
  </xsd:simpleType>
  <xsd:simpleType name="NumericString">
    <xsd:restriction base="xsd:string">
      <xsd:pattern value="[0-9]*"/>
    </xsd:restriction>
  </xsd:simpleType>
  <xsd:simpleType name="SimpleAttribute">
    <xsd:restriction base="xsd:boolean">
      <xsd:pattern value="true"/>
    </xsd:restriction>
  </xsd:simpleType>
  <xsd:simpleType name="CharacterSetType">
    <xsd:restriction base="xsd:NCName">
      <xsd:enumeration value="basic"/>
      <xsd:enumeration value="latin1"/>
    </xsd:restriction>
  </xsd:simpleType>
  <xsd:simpleType name="GeographicalType">
    <xsd:restriction base="xsd:NCName">
      <xsd:enumeration value="dec"/>
      <xsd:enumeration value="dms"/>
    </xsd:restriction>
  </xsd:simpleType>
  <xsd:attributeGroup name="CommAddressService">
    <xsd:attribute name="fax" type="SimpleAttribute" use="optional"/>
    <xsd:attribute name="pbx" type="SimpleAttribute" use="optional"/>
    <xsd:attribute name="txt" type="SimpleAttribute" use="optional"/>
    <xsd:attribute name="pub" type="SimpleAttribute" use="optional"/>
    <xsd:attribute name="vid" type="SimpleAttribute" use="optional"/>
    <xsd:attribute name="pag" type="SimpleAttribute" use="optional"/>
    <xsd:attribute name="voice" type="SimpleAttribute" use="optional"/>
    <xsd:attribute name="data" type="SimpleAttribute" use="optional"/>
    <xsd:attribute name="http" type="SimpleAttribute" use="optional"/>
    <xsd:attribute name="ftp" type="SimpleAttribute" use="optional"/>
    <xsd:attribute name="eml" type="SimpleAttribute" use="optional"/>
    <xsd:attribute name="sms" type="SimpleAttribute" use="optional"/>
    <xsd:attribute name="mms" type="SimpleAttribute" use="optional"/>
    <xsd:attribute name="emg" type="SimpleAttribute" use="optional"/>
  </xsd:attributeGroup>
  <xsd:attributeGroup name="InquiryCommAddressChar">
    <xsd:attribute name="ftn" type="SimpleAttribute" use="optional"/>
    <xsd:attribute name="mob" type="SimpleAttribute" use="optional"/>
    <xsd:attribute name="fixed" type="SimpleAttribute" use="optional"/>
  </xsd:attributeGroup>
  <xsd:attributeGroup name="ReplyCommAddressChar">
    <xsd:attributeGroup ref="InquiryCommAddressChar"/>
    <xsd:attribute name="prn" type="SimpleAttribute" use="optional"/>
    <xsd:attribute name="nprn" type="SimpleAttribute" use="optional"/>
  </xsd:attributeGroup>
</xsd:schema>
```



```
        </xsd:restriction>
      </xsd:simpleType>
    </xsd:attribute>
    <xsd:attribute name="providerCode" use="optional">
      <xsd:simpleType>
        <xsd:restriction base="E115String">
          <xsd:length value="3"/>
        </xsd:restriction>
      </xsd:simpleType>
    </xsd:attribute>
    <xsd:attribute name="requestedReplyType" use="optional" default="subscriberList">
      <xsd:simpleType>
        <xsd:restriction base="xsd:NCName">
          <xsd:enumeration value="subscriberList"/>
          <xsd:enumeration value="provinceList"/>
          <xsd:enumeration value="localityList"/>
          <xsd:enumeration value="streetList"/>
          <xsd:enumeration value="businessCategoryList"/>
        </xsd:restriction>
      </xsd:simpleType>
    </xsd:attribute>
  </xsd:complexType>
  <xsd:complexType name="InquiryData">
    <xsd:all>
      <xsd:element name="locality" type="E115StringUb256" minOccurs="0"/>
      <xsd:element name="subscriberName" type="E115StringUb256" minOccurs="0"/>
      <xsd:element name="streetName" type="E115StringUb256" minOccurs="0"/>
      <xsd:element name="houseNumber" type="E115StringUb256" minOccurs="0"/>
      <xsd:element name="forename" type="E115StringUb256" minOccurs="0"/>
      <xsd:element name="headingInTheGuide" type="E115StringUb256" minOccurs="0"/>
      <xsd:element name="professionCode" type="E115StringUb256" minOccurs="0"/>
      <xsd:element name="countyStateOrProvince" type="E115StringUb256" minOccurs="0"/>
      <xsd:element name="category" minOccurs="0">
        <xsd:complexType>
          <xsd:attributeGroup ref="Categories"/>
        </xsd:complexType>
      </xsd:element>
      <xsd:element name="postalCode" type="E115StringUb256" minOccurs="0"/>
      <xsd:element name="nationalDestinationCode" minOccurs="0">
        <xsd:simpleType>
          <xsd:restriction base="NumericString">
            <xsd:minLength value="1"/>
            <xsd:maxLength value="14"/>
          </xsd:restriction>
        </xsd:simpleType>
      </xsd:element>
      <xsd:element name="commAddress" type="E115StringUb256" minOccurs="0"/>
      <xsd:element name="commAddressTypes" minOccurs="0">
        <xsd:complexType>
          <xsd:attribute name="e164" type="SimpleAttribute" use="optional"/>
          <xsd:attribute name="rfc822" type="SimpleAttribute" use="optional"/>
          <xsd:attribute name="rfc1738" type="SimpleAttribute" use="optional"/>
        </xsd:complexType>
      </xsd:element>
      <xsd:element name="additionalName" type="E115StringUb256" minOccurs="0"/>
      <xsd:element name="commAddressService" minOccurs="0">
        <xsd:complexType>
          <xsd:attributeGroup ref="CommAddressService"/>
        </xsd:complexType>
      </xsd:element>
      <xsd:element name="commAddressChar" minOccurs="0">
        <xsd:complexType>
          <xsd:attributeGroup ref="InquiryCommAddressChar"/>
        </xsd:complexType>
      </xsd:element>
      <xsd:element name="searchCoordinate" minOccurs="0">
        <xsd:complexType>
          <xsd:all>
```

```
<xsd:element name="latitude" type="E115String"/>
<xsd:element name="longitude" type="E115String"/>
</xsd:all>
<xsd:attribute name="searchRadius" use="optional">
  <xsd:simpleType>
    <xsd:restriction base="NumericString">
      <xsd:minLength value="1"/>
      <xsd:maxLength value="9"/>
    </xsd:restriction>
  </xsd:simpleType>
</xsd:attribute>
<xsd:attribute name="geodeticDatum" type="E115String" use="optional"/>
<xsd:attribute name="projection" type="E115String" use="optional"/>
<xsd:attribute name="geographical" type="GeographicalType" use="optional"
  default="dec"/>
</xsd:complexType>
</xsd:element>
<xsd:element name="matchingRule" minOccurs="0">
  <xsd:complexType>
    <xsd:attribute name="wordRotation" type="xsd:boolean" use="optional"/>
    <xsd:attribute name="phonetic" type="xsd:boolean" use="optional"/>

    <xsd:attribute name="alias" type="xsd:boolean" use="optional"/>
  </xsd:complexType>
</xsd:element>
</xsd:all>
<xsd:attribute name="sequenceNumber" use="optional" default="0">
  <xsd:simpleType>
    <xsd:restriction base="NumericString">
      <xsd:minLength value="1"/>
      <xsd:maxLength value="2"/>
    </xsd:restriction>
  </xsd:simpleType>
</xsd:attribute>
<xsd:attribute name="geoExpansion" use="optional">
  <xsd:simpleType>
    <xsd:restriction base="NumericString">
      <xsd:minLength value="1"/>
      <xsd:maxLength value="3"/>
    </xsd:restriction>
  </xsd:simpleType>
</xsd:attribute>
<xsd:attribute name="maxSelectionLevel" type="NumericString" use="optional"
  default="99"/>
</xsd:complexType>
<xsd:complexType name="Reply">
  <xsd:sequence>
    <xsd:element name="replyHeader" type="ReplyHeader"/>
    <xsd:element name="selection" type="Selection" minOccurs="0"
      maxOccurs="unbounded"/>
  </xsd:sequence>
</xsd:complexType>
<xsd:complexType name="ReplyHeader">
  <xsd:all>
    <xsd:element name="message" type="E115StringUb256" minOccurs="0"/>
  </xsd:all>
  <xsd:attribute name="originatingTerminalCode" use="required">
    <xsd:simpleType>
      <xsd:restriction base="E115String">
        <xsd:length value="8"/>
      </xsd:restriction>
    </xsd:simpleType>
  </xsd:attribute>
  <xsd:attribute name="dateAndTime" use="optional">
    <xsd:simpleType>
      <xsd:restriction base="NumericString">
        <xsd:length value="12"/>
      </xsd:restriction>
    </xsd:simpleType>
  </xsd:attribute>
</xsd:complexType>
```

```
</xsd:simpleType>
</xsd:attribute>
<xsd:attribute name="messageNumber" use="optional">
  <xsd:simpleType>
    <xsd:restriction base="E115String">
      <xsd:length value="4"/>
    </xsd:restriction>
  </xsd:simpleType>
</xsd:attribute>
<xsd:attribute name="messageCode" use="required">
  <xsd:simpleType>
    <xsd:restriction base="E115String">
      <xsd:length value="2"/>
    </xsd:restriction>
  </xsd:simpleType>
</xsd:attribute>
<xsd:attribute name="dbSelectionCount" use="optional">
  <xsd:simpleType>
    <xsd:restriction base="E115String">
      <xsd:minLength value="1"/>
      <xsd:maxLength value="10"/>
    </xsd:restriction>
  </xsd:simpleType>
</xsd:attribute>
<xsd:attribute name="replyCharacterSet" type="CharacterSetType" use="optional"/>
</xsd:complexType>
<xsd:complexType name="Selection">
  <xsd:all>
    <xsd:element name="nationalDestinationCode" minOccurs="0">
      <xsd:simpleType>
        <xsd:restriction base="NumericString">
          <xsd:minLength value="1"/>
          <xsd:maxLength value="14"/>
        </xsd:restriction>
      </xsd:simpleType>
    </xsd:element>
    <xsd:element name="commAddress" type="E115StringUb256" minOccurs="0"/>
    <xsd:element name="locality" type="E115StringUb256" minOccurs="0"/>
    <xsd:element name="subscriberName" type="E115StringUb256" minOccurs="0"/>
    <xsd:element name="forename" type="E115StringUb256" minOccurs="0"/>
    <xsd:element name="streetName" type="E115StringUb256" minOccurs="0"/>
    <xsd:element name="houseNumber" type="E115StringUb256" minOccurs="0"/>
    <xsd:element name="supplementaryData" type="E115StringUb256" minOccurs="0"/>
    <xsd:element name="subscriberMessage" type="E115StringUb256" minOccurs="0"/>
    <xsd:element name="headingInTheGuide" type="E115StringUb256" minOccurs="0"/>
    <xsd:element name="professionCode" type="E115StringUb256" minOccurs="0"/>
    <xsd:element name="countyStateOrProvince" type="E115StringUb256" minOccurs="0"/>
    <xsd:element name="subscriberDescription" type="E115StringUb256" minOccurs="0"/>
    <xsd:element name="category" minOccurs="0">
      <xsd:complexType>
        <xsd:attributeGroup ref="Categories"/>
      </xsd:complexType>
    </xsd:element>
    <xsd:element name="countryCode" minOccurs="0">
      <xsd:simpleType>
        <xsd:restriction base="NumericString">
          <xsd:minLength value="1"/>
          <xsd:maxLength value="3"/>
        </xsd:restriction>
      </xsd:simpleType>
    </xsd:element>
    <xsd:element name="postalCode" type="E115StringUb256" minOccurs="0"/>
    <xsd:element name="commAddressService" minOccurs="0">
      <xsd:complexType>
        <xsd:attributeGroup ref="CommAddressService"/>
      </xsd:complexType>
    </xsd:element>
    <xsd:element name="commAddressChar" minOccurs="0">
```

```
<xsd:complexType>
  <xsd:attributeGroup ref="ReplyCommAddressChar"/>
</xsd:complexType>
</xsd:element>
<xsd:element name="distance" type="E115StringUb256" minOccurs="0"/>
<xsd:element name="searchCenter" type="E115StringUb256" minOccurs="0"/>
<xsd:element name="additionalName" type="E115StringUb256" minOccurs="0"/>
<xsd:element name="selectionCoordinate" minOccurs="0">
  <xsd:complexType>
    <xsd:all>
      <xsd:element name="latitude" type="E115String"/>
      <xsd:element name="longitude" type="E115String"/>
    </xsd:all>
    <xsd:attribute name="geodeticDatum" type="E115String" use="optional"/>
    <xsd:attribute name="projection" type="E115String" use="optional"/>
    <xsd:attribute name="geographical" type="GeographicalType" use="optional"
      default="dec"/>
  </xsd:complexType>
</xsd:element>
</xsd:all>
<xsd:attribute name="commAddressType" use="optional">
  <xsd:simpleType>
    <xsd:restriction base="xsd:NCName">
      <xsd:enumeration value="e164"/>
      <xsd:enumeration value="rfc822"/>
      <xsd:enumeration value="rfc1738"/>
    </xsd:restriction>
  </xsd:simpleType>
</xsd:attribute>
<xsd:attribute name="selectionLevel" use="optional" default="0">
  <xsd:simpleType>
    <xsd:restriction base="NumericString">
      <xsd:minLength value="1"/>
      <xsd:maxLength value="3"/>
    </xsd:restriction>
  </xsd:simpleType>
</xsd:attribute>
</xsd:complexType>
<xsd:element name="e115Message" type="E115Message"/>
</xsd:schema>
```

Annex E

Message codes for the Recommendation E.115

(This annex forms an integral part of this Recommendation)

The message codes are structured as follows:

- The first digit reflects the subdivision.
- The second digit reflects the detailed code within the subdivision.

The code giving the most detail about the message shall be used where possible.

Message codes apply for both version 1 and 2, unless exception is explicitly mentioned.

The following codes have been defined:

20 PROTOCOL ERROR

- Default code for this subdivision.
 - The inquiry message is not structured according to this Recommendation.
 - The inquiry message is returned when possible (version 1 only).
- 21 Lack of respect the ASN1 description of this Recommendation
- E.g. – Wrong structure of the inquiry message.
 - Mandatory fields not present in the inquiry message.
- 22 The syntax in a field is not in accordance to the E.115 description
- E.g. – The data specified in field “Sequence number” is not a number.
- 23 Characters not accepted by this Recommendation
- The existence of this message code must not be taken as an invitation not to fully implement this Recommendation.

30 SYSTEM ERROR

- Default code for this subdivision.
 - The inquiry message is returned when possible (version 1 only).
 - The existence of this message code must not be taken as an invitation not to fully implement this Recommendation.
- 31 Database not accessible
- e.g. – Locality list not working.
 - Database subsystem not working.
 - The existence of this message code must not be taken as an invitation not to fully implement this Recommendation.
- 32 Congestion with the system
- The existence of this message code must not be taken as an invitation not to fully implement this Recommendation.
- 33 Error due to the application
- Please contact the replying system administrator.

40 REQUIRED SERVICE NOT SUPPORTED

- Default code for this subdivision.
 - The inquiry message is returned for version 1, only.
- 41 Search for the subscriber within the whole country not supported
- 42 Search for the subscriber within the County, State or Province not supported
- 43 The system only allows this search when prior agreement exists. - This gives an indication to the inquiring system that this search is possible if an agreement exists.

- 44 Search for the subscriber without subscriber name not supported.
- 45 Requested reply type not supported (version 2 only)
- 46 Requested matching rule not supported (version 2 only)
- 47 Search for the street within the whole country not supported (version 2 only)
- 48 Search for the street within the County, State or Province not supported (version 2 only)
- 49 Search for the Heading in the guide within the whole country not supported (version 2 only)
- 4A Search for the Heading in the guide within the County, State or Province not supported (version 2 only)

50 REQUIRED SERVICE SUPPORTED BUT SEARCH IMPOSSIBLE BY LACK OF, OR INVALID, INPUT INFORMATION

- Default code for this subdivision.
- The inquiry message is returned (version 1 only).
- 51 Not enough information in the Locality name
- 52 Not enough information in the County, State or Province name
- 53 Not enough information in the subscriber's name
- 54 Not enough information in other fields (excluding Locality, County, State or Province, subscriber name, street name, Heading in the Guide)
- 55 The information in the additional information field is invalid – See Operator Manual
- 56 Invalid characters in the locality name – See Operator Manual
- 57 Invalid sequence number
 - e.g. – Sequence number exceeds the limit of the replying system.
 - Sequence number out of numerical sequence.
- 58 Not enough information in the Street name (version 2 only).
- 59 Not enough information in the Heading in the Guide (version 2 only).

60 UNABLE TO DETERMINE THE GEOGRAPHICAL AREA IN WHICH TO SEARCH

- Default code for this subdivision.
- These codes may only be used when the called system cannot provide additional information by using the locality list.

An example can be that when a locality is not found within a specified County, State or Province, all selected localities within the Country are displayed in the locality list. Such functionality is not required by this Recommendation, but is not rejected by it as well.
- 61 County, State or Province name does not exist in the system
- 62 Locality name does not exist in the system
- 63 The combination County, State or Province name – Locality name does not exist in the system
- 64 The combination Locality – Street name not defined
 - The street name does not exist within the locality.
 - Too many street names found within the locality (version 1 only, message code 58 in version 2).
- 65 Too many selections found
 - Too many counties, states or provinces or localities found.
 - The existence of this message code must not be taken as an invitation not to fully implement this Recommendation.
- 66 The combination Locality – Business category not defined (version 2 only).
- 67 Street name does not exist in the system (version 2 only).
- 68 Business category does not exist in the system (version 2 only).

70 RETURNING A LOCALITY LIST

- A default code for the locality list is not appropriate as information about a complete or incomplete selection is needed.
- 71 The locality list is complete – No more information can be obtained
- 72 The locality list is incomplete – More information can be obtained
- 73 The locality list is incomplete (10th subdivision is given) – No more information can be obtained
- 74 The locality list is incomplete (10th subdivision is not reached) – No more information can be obtained
- 75 The locality list is probably incomplete – No more information can be obtained.
 - Due to database difficulties, the replying system cannot assure that all selections are made
 - The existence of this message code must not be taken as an invitation not to fully implement this Recommendation.

NOTE – A reply containing message code of subdivision 7 with a locality list should be sent if there is no subscriber name in the inquiry or if the locality given in the inquiry is ambiguous. Every entry in the locality list will describe a locality, it will include the locality name and the province name (if supported in that country), if there is a meaningful relation between localities and national destination code, the national destination code will also be included. In that case, the national destination code will be entered in the field “national destination code”. Whenever there is additional information that could be useful to the end user, this will be entered in the field “Supplementary data”.

The combination of locality name and province name (in the locality list) will be such that they can be used for an international inquiry format message, resulting in subscribers being returned.

- 76 List of business categories (version 1 only)
- 77 List of street addresses (version 1 only)

80 RETURNING A SUBSCRIBER LIST

- A default code for the Subscriber list is not appropriate as information about a complete or incomplete selection is needed.
- 81 The subscriber list is complete – No more information can be obtained
- 82 The subscriber list is incomplete – More information can be obtained
- 83 The subscriber list is incomplete (the 10th subdivision is given) – No more information can be obtained
- 84 The subscriber list is incomplete (the 10th subdivision is not reached) – No more information can be obtained
- 85 The subscriber list is probably incomplete – No more information can be obtained.
 - Due to database difficulties the replying system cannot assure that all selections are made
 - The existence of this message code must not be taken as an invitation not to fully implement this Recommendation.

90 THE SEARCH RESULTS IN NO LOCALITY – OR SUBSCRIBER SELECTION

- Default code for this subdivision.
- The inquiry message is returned. (version 1 only)
- 91 Heading in the guide not found
- 92 No subscriber information found
- 93 Too many selections found – Enter more selective information
- 94 No locality selection found with the specified sequence number
- 95 No subscriber information found with the specified sequence number
- 96 Subscriber’s information not available for selected geographical area
- 97 No province selection found with the specified sequence number
- 98 No street selection found with the specified sequence number
- 99 No business category selection found with the specified sequence number

P0 RETURNING A PROVINCE LIST

- This set of message codes is for version 2 only

- A default code for the province list is not appropriate as information about a complete or incomplete selection is needed.
- P1 The province list is complete – No more information can be obtained
- P2 The province list is incomplete – More information can be obtained
- P3 The province list is incomplete (10th subdivision is given) – No more information can be obtained
- P4 The province list is incomplete (10th subdivision is not reached) – No more information can be obtained
- P5 The province list is probably incomplete – No more information can be obtained.

S0 RETURNING A STREET LIST

- This set of message codes is for version 2 only
- A default code for the street list is not appropriate as information about a complete or incomplete selection is needed.
- S1 The street list is complete – No more information can be obtained
- S2 The street list is incomplete – More information can be obtained
- S3 The street list is incomplete (10th subdivision is given) – No more information can be obtained
- S4 The street list is incomplete (10th subdivision is not reached) – No more information can be obtained
- S5 The street list is probably incomplete – No more information can be obtained.

B0 RETURNING A BUSINESS CATEGORY LIST

- This set of message codes is for version 2 only
- A default code for the business category list is not appropriate as information about a complete or incomplete selection is needed.
- B1 The business category list is complete – No more information can be obtained
- B2 The business category list is incomplete – More information can be obtained
- B3 The business category list is incomplete (the 10th subdivision is given) – No more information can be obtained
- B4 The business category list is incomplete (the 10th subdivision is not reached) – No more information can be obtained
- B5 The business category list is probably incomplete – No more information can be obtained.

Annex F

NACE nomenclature

(This annex does not form an integral part of this Recommendation)

F.1 About NACE

The NACE (Nomenclature générale des Activités économiques dans la Communauté Européenne - General industrial classification of economic activities within the European communities) has been accepted as a good nomenclature to be used for of International DA to represent business categories.

NACE was established in order to get a common statistical classification of economic activities within the European Community.

F.2 NACE structure

NACE has the following hierarchical structure:

- A first level consisting of headings identified by an alphabetical code (sections), an intermediate level consisting of headings identified by a two-character alphabetical code (subsections).
- A second level consisting of headings identified by a two-digit numerical code (divisions).
- A third level consisting of headings identified by a three-digit numerical code (groups).
- A fourth level consisting of headings identified by a four-digit numerical code (classes).

More detailed information can be found on the official Web site with the complete NACE in English

http://europa.eu.int/comm/competition/mergers/cases/index/nace_all.html

F.3 NACE at work

It is recommended for service providers to implement the NACE nomenclature. This will reduce language problems for international inquiries.

To make an inquiry, the Recipient's operator enters a NACE code in the **headingInTheGuide** field. The replying system may then, if required, translates the NACE code into the matching Business Category for the system.

NOTE – The NACE nomenclature could also be implemented by the inquiring system. A human user could enter the Business Category in her or his own language and the system translates that to the corresponding NACE code.

The number of the minimum code is 1 character (ex: B fishing), the maximum is 6 (ex: DA1583 manufacture of sugar).

Subheadings should be possible according to the NACE index but you shall always get all information with the heading.

If somebody uses subentries in the database like N851 and N852 and somebody searches for N85, then all listings with N85, N851, N852 should be delivered.

If an unknown code is provided (example: 12345), a message code 91 shall be returned (heading in the guide not found)

The idea is to recommend the business categories of the NACE list with each provider being free to adapt his database entries in more or less detail. It might not be necessary to implement the full list but only a part of it. If, and how, it is implemented should be described in the Operator Manual.

F.4 Extract from NACE

Below is an extract of the most commonly used NACE codes. It is recommended that at least these codes should be supported.

business category name	nearest NACE code(s)
airports	I62

business category name	nearest NACE code(s)
banks	J65
customs offices and border crossing points	L7521
embassies and consulates	Q99
hospitals, clinics and medical centres (private and public)	N8511
hotels	H551
insurance companies	J66
local administration	L7510
ministries	L75
museums	O925
police stations	L7524
port and harbour administration	I61
post offices	I6411
railway stations	I6010
registry offices	L7510
restaurants	H553
schools and universities	M80
tourist information offices	I6330
travel agencies	I6330

Annex G

Examples of BER encodings

(This annex does not form an integral part of this Recommendation)

G.1 Introduction

This annex provides examples of BER encoding of the DA protocol version 1 and 2. This examples illustrates the encoding and can possibly be an implementation aid.

The BER encoding has options. Length fields may be coded in two ways (explicit length fields and indefinite length fields) and as the DA protocol is using the SET constructed data type, components within such a SET may be transmitted in any order and still be compliant.

An implementation should be able to cope with such variations.

G.2 Example of ASN.1 BER encoding of the DA protocol version 1

G.2.1 Inquiry message

1010 0000 LENGTH	Directory message (telephone)
1010 0000 LENGTH	Telephone (inquiry)
0011 0000 LENGTH	Inquiry
0110 0000 LENGTH	Part 1
1000 0000 LENGTH	Message indicators
Message indicators	
1000 0001 LENGTH	International indicators
International indicators	
1000 0010 LENGTH	Originating terminal code
Originating terminal code	
1000 0011 LENGTH	Date and time (optional)
Date and time	
1000 0100 LENGTH	Message number (optional)
Message number	
0110 0001 LENGTH	Part 2
1000 0000 LENGTH	Locality (optional)
Locality	
1000 0001 LENGTH	Subscriber name (optional)
Subscriber name	
1000 0010 LENGTH	Street name (optional)
Street name	

1000 0011 House number (optional)
LENGTH
 House number
1000 0100 Forename (optional)
LENGTH
 Forename
1000 0101 Heading in the Guide (optional)
LENGTH
 Heading in the Guide
1000 0110 Profession code (optional)
LENGTH
 Profession Code
1000 0111 Additional information for a selective search (optional)
LENGTH
 Additional information for a selective search
1000 1000 County, State or Province (optional)
LENGTH
 County, State or Province
1000 1001 Category (optional)
LENGTH
 Category
1000 1010 Sequence number (optional)
LENGTH
 Sequence number

G.2.2 Reply message

1010 0000 Directory message (telephone)
LENGTH
 1010 0001 Telephone (reply)
 LENGTH
 0011 0000 Reply
 LENGTH
 0110 0011 Part 1
 LENGTH
 1000 0000 Message indicators
 LENGTH
 Message indicators
 1000 0001 International indicators
 LENGTH
 International indicators
 1000 0010 Originating terminal code
 LENGTH
 Originating terminal code
 1000 0011 Date and time (optional)
 LENGTH
 Date and Time

1000 0100 LENGTH	Message number (optional)
Message number	
0110 0100 LENGTH	Part 2
1000 0000 LENGTH	Message code
Message code	
1000 0001 LENGTH	Country code
Country code	
1000 0010 LENGTH	Message (optional)
Message	
1000 0011 LENGTH	DB Selection Count (optional)
DB selection count	
0110 0101 LENGTH	Part 3 (optional)
0011 0001 Selection LENGTH	
1000 0000 LENGTH	National destination code (optional)
National Destination code	
1000 0001 LENGTH	Subscriber number (optional)
Subscriber number	
1000 0010 LENGTH	Locality
Locality	
1000 0011 LENGTH	Subscriber name (optional)
Subscriber name	
1000 0100 LENGTH	Forename (optional)
Forename	
1000 0101 LENGTH	Street name (optional)
Street name	
1000 0110 LENGTH	House number (optional)
House number	
1000 0111 LENGTH	Supplementary data (optional)
Supplementary data	
1000 1000 LENGTH	Subscriber message (optional)
Subscriber message	
10000 1001 LENGTH	Heading in the Guide (optional)
Heading in the Guide	
1000 1010 LENGTH	Profession code (optional)
Profession code	

1000 1011	Additional information for a selective search (optional)
LENGTH	Additional information for a selective search
1000 1100	County, State or Province (optional)
LENGTH	County, State or Province (optional)
1000 1101	Category (optional)
LENGTH	Category
1000 1110	Subscriber description
LENGTH	Subscriber description
0011 0001	Selection
LENGTH	
1000 0000	National Destination code (optional)
LENGTH	National destination code

etc.

G.3 Example of ASN.1 BER encoding of the DA protocol version 2

G.3.1 Inquiry message

1010 0000	Directory message (telephone)
LENGTH	
1010 0000	Telephone (inquiry)
LENGTH	
0011 0000	Inquiry
LENGTH	
0110 0000	Part 1
LENGTH	
1000 0000	Message indicators
LENGTH	Message indicators
1000 0001	International indicators
LENGTH	International indicators
1000 0010	Originating terminal code
LENGTH	Originating terminal code
1000 0011	Date and time (optional)
LENGTH	Date and time

1000 0100	Message number (optional)
LENGTH	
Message number	
0110 0001	Part 2
LENGTH	
1000 0000	Locality (optional)
LENGTH	
Locality	
1000 0001	Subscriber name (optional)
LENGTH	
Subscriber name	
1000 0010	Street name (optional)
LENGTH	
Street name	
1000 0011	House number (optional)
LENGTH	
House number	
1000 0100	Forename (optional)
LENGTH	
Forename	
1000 0101	Heading in the Guide (optional)
LENGTH	
Heading in the Guide	
1000 0110	Profession code (optional)
LENGTH	
Profession Code	
1000 1000	County, State or Province (optional)
LENGTH	
County, State or Province	
1000 1010	Sequence number (optional)
LENGTH	
Sequence number	
1010 1011	Category (optional)
LENGTH	
1000 0000	Business (optional)
LENGTH (=0000 0001)	
1111 1111	
1000 0001	Residential (optional)
LENGTH (=0000 0001)	
1111 1111	
1000 0010	Government (optional)

LENGTH (=0000 0001)
1111 1111

1000 1100 Postal code (optional)

LENGTH
Postal code

1000 1101 National destination code (optional)

LENGTH
National destination code

1000 1110 Communication address (optional)

LENGTH
Communication address

1010 1111 Communication address type (optional)

LENGTH
1000 0000 E164 (optional)

LENGTH (=0000 0001)
1111 1111

1000 0001 RFC822 (optional)

LENGTH (=0000 0001)
1111 1111

1000 0010 RFC1738 (optional)

LENGTH (=0000 0001)
1111 1111

1001 0000 Additional name (optional)

LENGTH
Additional name

1001 0001 Requested Reply Type (optional)

LENGTH (=0000 0001)
0000 0xxx, where xxx is 000 to 100 with default 000

1011 0010 Accepted Reply Types (optional)

LENGTH
1000 0000 provinceList (optional)

LENGTH (=0000 0001)
1111 1111

1000 0001 localityList (optional)

LENGTH (=0000 0001)
1111 1111

1000 0010 streetList (optional)

LENGTH (=0000 0001)
1111 1111

1000 0011 businessCategoryList (optional)

LENGTH (=0000 0001)

1111 1111
1001 0011 Country name (optional)
LENGTH (=0000 0010)
Country name
1001 0100 Provider code (optional)
LENGTH (=0000 0011)
Provider code
0110 0010 Part 3
LENGTH
1010 0000 Communication address service (optional)
LENGTH
1000 0000 fax (optional)
LENGTH (=0000 0001)
1111 1111
1000 0001 bpx (optional)
LENGTH (=0000 0001)
1111 1111
1000 0010 txt (optional)
LENGTH (=0000 0001)
1111 1111
1000 0011 pub (optional)
LENGTH (=0000 0001)
1111 1111
1000 0100 vid (optional)
LENGTH (=0000 0001)
1111 1111
1000 0101 pag (optional)
LENGTH (=0000 0001)
1111 1111
1000 0110 voice (optional)
LENGTH (=0000 0001)
1111 1111
1000 0111 data (optional)
LENGTH (=0000 0001)
1111 1111
1000 1000 http (optional)
LENGTH (=0000 0001)
1111 1111
1000 1001 ftp (optional)
LENGTH (=0000 0001)
1111 1111

1000 1010 eml (optional)
LENGTH (=0000 0001)
1111 1111

1000 1011 sms (optional)
LENGTH (=0000 0001)
1111 1111

1000 1100 mms (optional)
LENGTH (=0000 0001)
1111 1111

1010 0001 Communication address characteristics (optional)
LENGTH

1000 0000 fnt (optional)
LENGTH (=0000 0001)
1111 1111

1000 0001 mob (optional)
LENGTH (=0000 0001)
1111 1111

1000 0010 fixed (optional)
LENGTH (=0000 0001)
1111 1111

1000 0010 Geographical extension (optional)
LENGTH
Geographical extension

1000 0011 Search radius (optional)
LENGTH
Search radius

1000 0100 Search coordinate (optional)
LENGTH
Search coordinate

1000 0101 Inquiry character set
LENGTH (=0000 0001)
0000 000x, where x is 0 or 1 with default 0

1000 0110 Reply character set
LENGTH (=0000 0001)
0000 000x, where x is 0 or 1 with default 1

1010 0111 Matching rule (optional)
LENGTH

1000 0000 Word rotation match (optional)
LENGTH (=0000 0001)
xxxx xxxx, where each x is 0 for false and 1 for true

1000 0001 Phonetic match (optional)

LENGTH (=0000 0001)
xxxx xxxx, where each x is 0 for false and 1 for true
1000 0010 Alias match (optional)
LENGTH (=0000 0001)
xxxx xxxx, where each x is 0 for false and 1 for true
1000 1000 Maximum selection level (optional)
LENGTH
Maximum selection level

G.3.2 Reply message

1010 0000 Directory message (telephone)
LENGTH
1010 0001 Telephone (reply)
LENGTH
0011 0000 Reply
LENGTH
0110 0011 Part 1
LENGTH
1000 0000 Message indicators
LENGTH
Message indicators
1000 0001 International indicators
LENGTH
International indicators
1000 0010 Originating terminal code
LENGTH
Originating terminal code
1000 0011 Date and time (optional)
LENGTH
Date and Time
1000 0100 Message number (optional)
LENGTH
Message number
0110 0100 Part 2
LENGTH
1000 0000 Message code
LENGTH
Message code
1000 0010 Message (optional)
LENGTH
Message

1000 0011 DB Selection Count (optional)
LENGTH
 DB selection count

1000 0100 Reply character set (optional)
LENGTH (= 0000 0001)
 0000 000x, where x is 0 or 1

0110 0101 Part 3 (optional)
LENGTH
 0011 0001 Selection
LENGTH
 1000 0000 National destination code (optional)
LENGTH
 National Destination code

1000 0001 Communication address (optional)
LENGTH
 Communication address

1000 0010 Locality (optional)
LENGTH
 Locality

1000 0011 Subscriber name (optional)
LENGTH
 Subscriber name

1000 0100 Forename (optional)
LENGTH
 Forename

1000 0101 Street name (optional)
LENGTH
 Street name

1000 0110 House number (optional)
LENGTH
 House number

1000 0111 Supplementary data (optional)
LENGTH
 Supplementary data

1000 1000 Subscriber message (optional)
LENGTH
 Subscriber message

10000 1001 Heading in the Guide (optional)
LENGTH
 Heading in the Guide

1000 1010 Profession code (optional)

LENGTH

Profession code

1000 1100 County, State or Province (optional)

LENGTH

County, State or Province

1000 1110 Subscriber description (optional)

LENGTH

Subscriber description

1010 1111 Category (optional)

LENGTH

1000 0000 Business (optional)

LENGTH (=0000 0001)

1111 1111

1000 0001 Residential (optional)

LENGTH (=0000 0001)

1111 1111

1000 0010 Government (optional)

LENGTH (=0000 0001)

1111 1111

1001 0000 Country code (optional)

LENGTH

Country code

1001 0001 Postal code (optional)

LENGTH

Postal code

1001 0010 Communication address type (optional)

LENGTH

0000 00xx, where xx is 00 to 10

1011 0011 Communication address service (optional)

LENGTH

1000 0000 fax (optional)

LENGTH (=0000 0001)

1111 1111

1000 0001 bpx (optional)

LENGTH (=0000 0001)

1111 1111

1000 0010 txt (optional)

LENGTH (=0000 0001)

1111 1111

1000 0011 pub (optional)

LENGTH (=0000 0001)

1111 1111
1000 0100 vid (optional)
LENGTH (=0000 0001)
1111 1111
1000 0101 pag (optional)
LENGTH (=0000 0001)
1111 1111
1000 0110 voice (optional)
LENGTH (=0000 0001)
1111 1111
1000 0111 data (optional)
LENGTH (=0000 0001)
1111 1111
1000 1000 http (optional)
LENGTH (=0000 0001)
1111 1111
1000 1001 ftp (optional)
LENGTH (=0000 0001)
1111 1111
1000 1010 eml (optional)
LENGTH (=0000 0001)
1111 1111
1000 1011 sms (optional)
LENGTH (=0000 0001)
1111 1111
1000 1100 mms (optional)
LENGTH (=0000 0001)
1111 1111
1011 0100 Communication address characteristics (optional)
LENGTH
1000 0000 fnt (optional)
LENGTH (=0000 0001)
1111 1111
1000 0001 mob (optional)
LENGTH (=0000 0001)
1111 1111
1000 0010 fixed (optional)
LENGTH (=0000 0001)
1111 1111
1000 0011 prn (optional)
LENGTH (=0000 0001)

1111 1111
1000 0100 npn (optional)
LENGTH (=0000 0001)
1111 1111
1000 0101 upn (optional)
LENGTH (=0000 0001)
1111 1111
1000 0110 old (optional)
LENGTH (=0000 0001)
1111 1111
1000 0111 adv (optional)
LENGTH (=0000 0001)
1111 1111
1000 1000 nmk (optional)
LENGTH (=0000 0001)
1111 1111
1001 0101 Distance (optional)
LENGTH
Distance
1001 0110 Search center (optional)
LENGTH
Search center
1001 0111 Additional name (optional)
LENGTH
Additional name
1001 1000 Selection coordinate (optional)
LENGTH
Subscriber coordinate
1001 1001 Selection level (optional)
LENGTH
Selection level

0011 0001 Selection
LENGTH
1000 0000 National Destination code (optional)
LENGTH
National destination code

etc.